

Specialized Network Cabinets
Experts in Confidential Cabinets

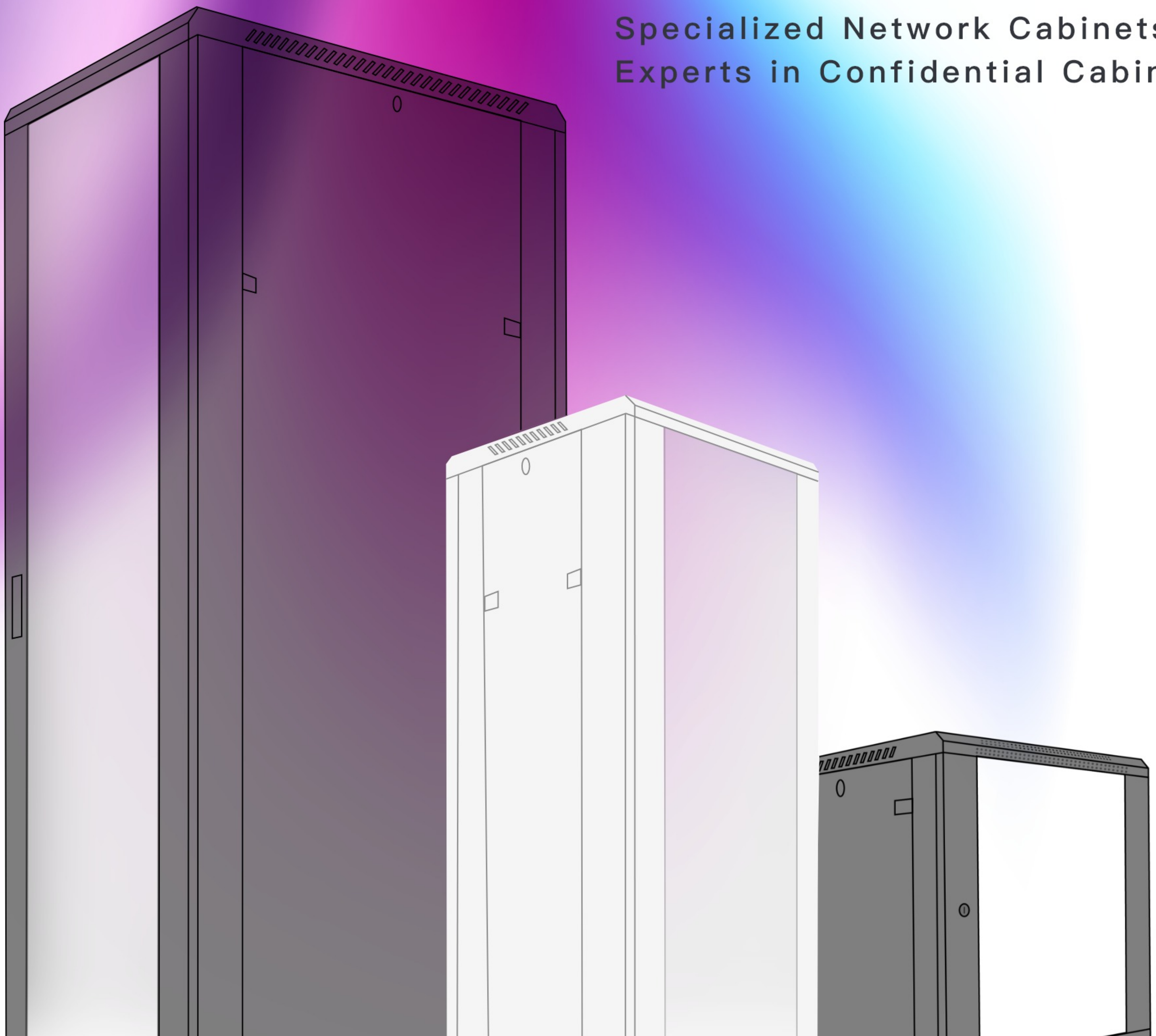

Main Products:

- Network Cabinet
- Server Cabinet
- Computer Cabinet
- Equipment Cabinet
- Cabinet Shelf
- Cabinet Sliding Shelf
- Fan Units
- Cabinet Accessories
- Telecommunication Related Products
- Surveillance System Related Products



Mail : service@anp.tw

Web : www.anp.tw Line@ : @anp.tw



【ANP】 – Advanced Networking Products Co., Ltd. was established in 1994, selling network cabinets and accessories to global cabling industries and data centers. Observing the “Cabinet” domestic market in Taiwan, 【ANP】 accessed into “Cabinet” domestic market with extraordinary business advantages on “Premium Quality Cheerful Price” in 2005. Gratefully 【ANP】 has won the superior reputation on “Quality, Price, Delivery & Service” in the “Cabinet” domestic market, and become the designated brand by system integrators, government, hospitals, schools...etc. In order to work and serve customers better, 【ANP】 expands product line widely with C5E, C6, C6A cabling products and surveillance devices, providing one-stop-shop with ease and convenience. Hopefully you and 【ANP】 work together, strong together toward the future.

Taoyuan:

TEL:03-313-6528

FAX:03-313-6529

No. 31, Ln. 290, Xincheng Rd., Luzhu Dist.,
Taoyuan City 338003, Taiwan (R.O.C.)

Taipei:

TEL:02-2871-7002

FAX:02-2871-7003

Business Hours: Monday – Friday AM9:00–PM5:00

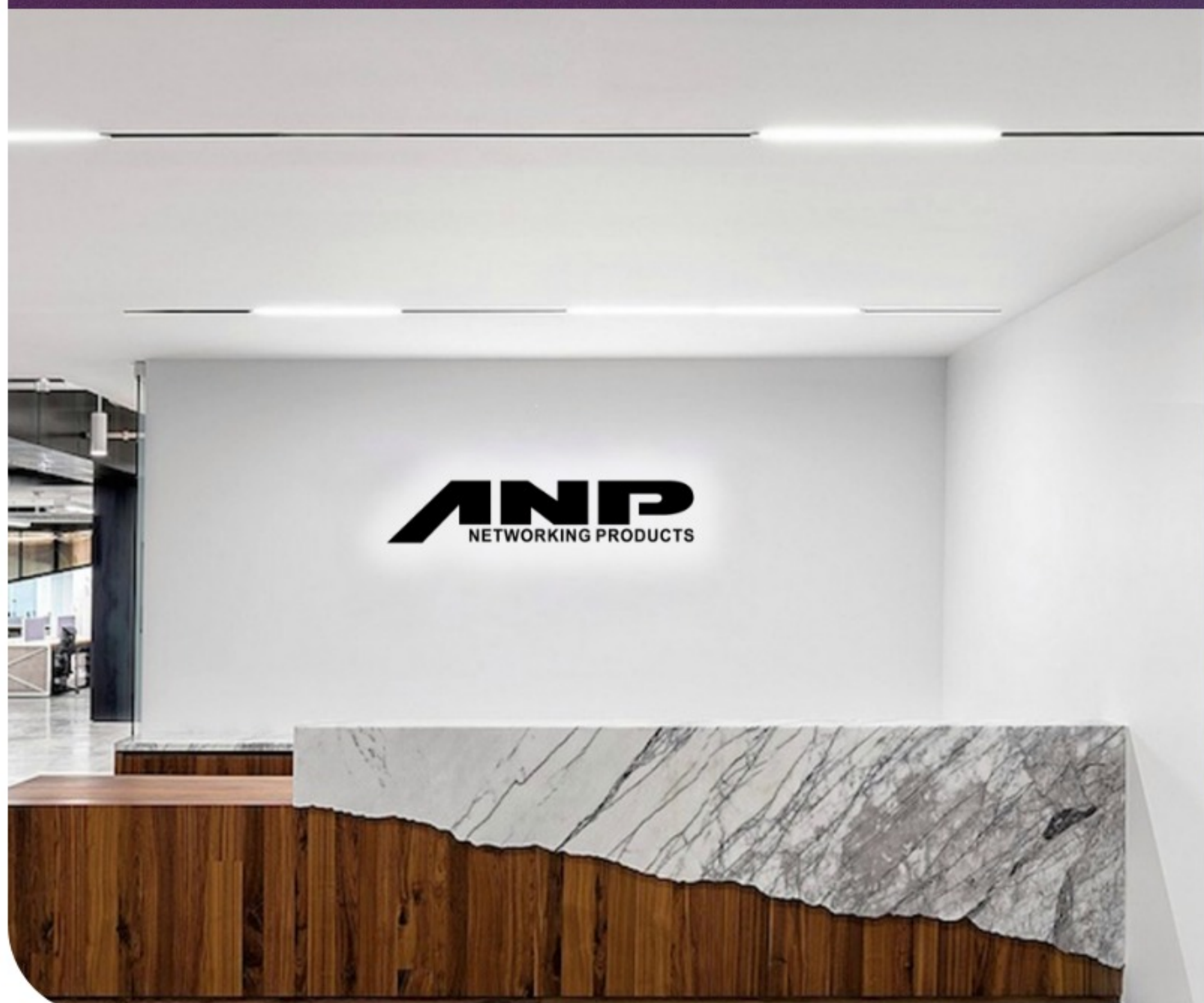

Category Index

PAGE | 4

Network Cabinet

Glass Front/Metal Rear Door Cabinet
Vented Front/Rear Door Cabinet
FTTH Networking Cabinet

PAGE | 10

Wall Mount Cabinet

Wall Mount Single Section Cabinet

PAGE | 13

Wall Mount Bracket

Wall Mount Bracket

PAGE | 13

Shelf

Fixed Shelf
Fixed Shelf with Mounting Ears
Cantilever Shelf
Sliding Shelf

PAGE | 16

Fan Unit

Network Cabinet Fan Unit
Wall Mount Cabinet Fan Unit
1U Universal Fan Unit
3U Universal Fan Unit

PAGE | 18

Cable Management

Cable Management with Cap
Cable Management with Rings
C Ring Cable Hook
D Ring Cable Hook

Monitor Mounting Bracket

Monitor Mounting Bracket Angle Adjustable

Monitor Mounting Bracket Flat

Monitor Arm

Accessories

Network Cabinet Flat Cover

1U Brush Strip

Base Brush Strip

L Rail

Blank Panel

Screw and Nut with Cushion

Cabinet connecting bracket

Wall Mount Cabinet Castors

1U Universal Equipment Mounting Plate

2U Universal Equipment Mounting Plate

Power Distribution Unit

6 Outlet PDU (Power Distribution Unit)

8 Outlet PDU (Power Distribution Unit)

Networking Accessories

Patch Cord

Cat3 RJ12 Keystone Jack

Cat6 RJ45 90° Keystone Jack

Cat6 RJ45 180° Keystone Jack

Cat6 12 Ports Patch Panel

24 Port Blank Patch Panel

Cat6 24 Ports Patch Panel

Cat6 25 Ports Patch Panel

Cabinet Door Locks

Cabinet Side Doors Lock

Spring Lock

Electronic Cabinet Smart Lock

22U 32U 42U Networking Cabinet with 600mm Width

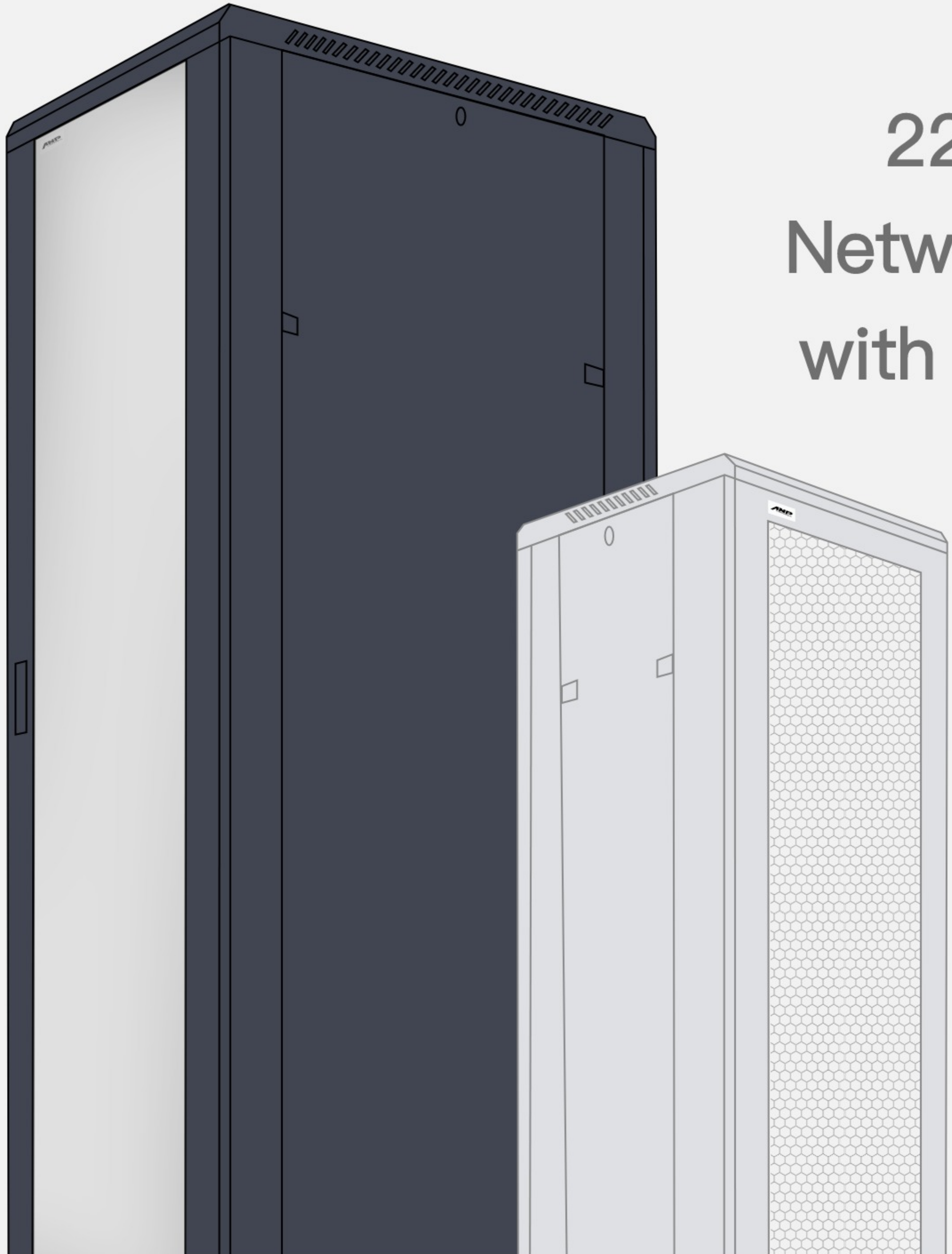

Comply with ANSI / EIA RS-310-D 、 IEC297-2 、 DIN41491PART1 、 DIN41494 ; PART7 、 GB/T3047.2-92

Toughened glass front door



Exquisite design with precise dimension and craftsmanship. Hexagonal reticular high-density vented plate front door and rear door.

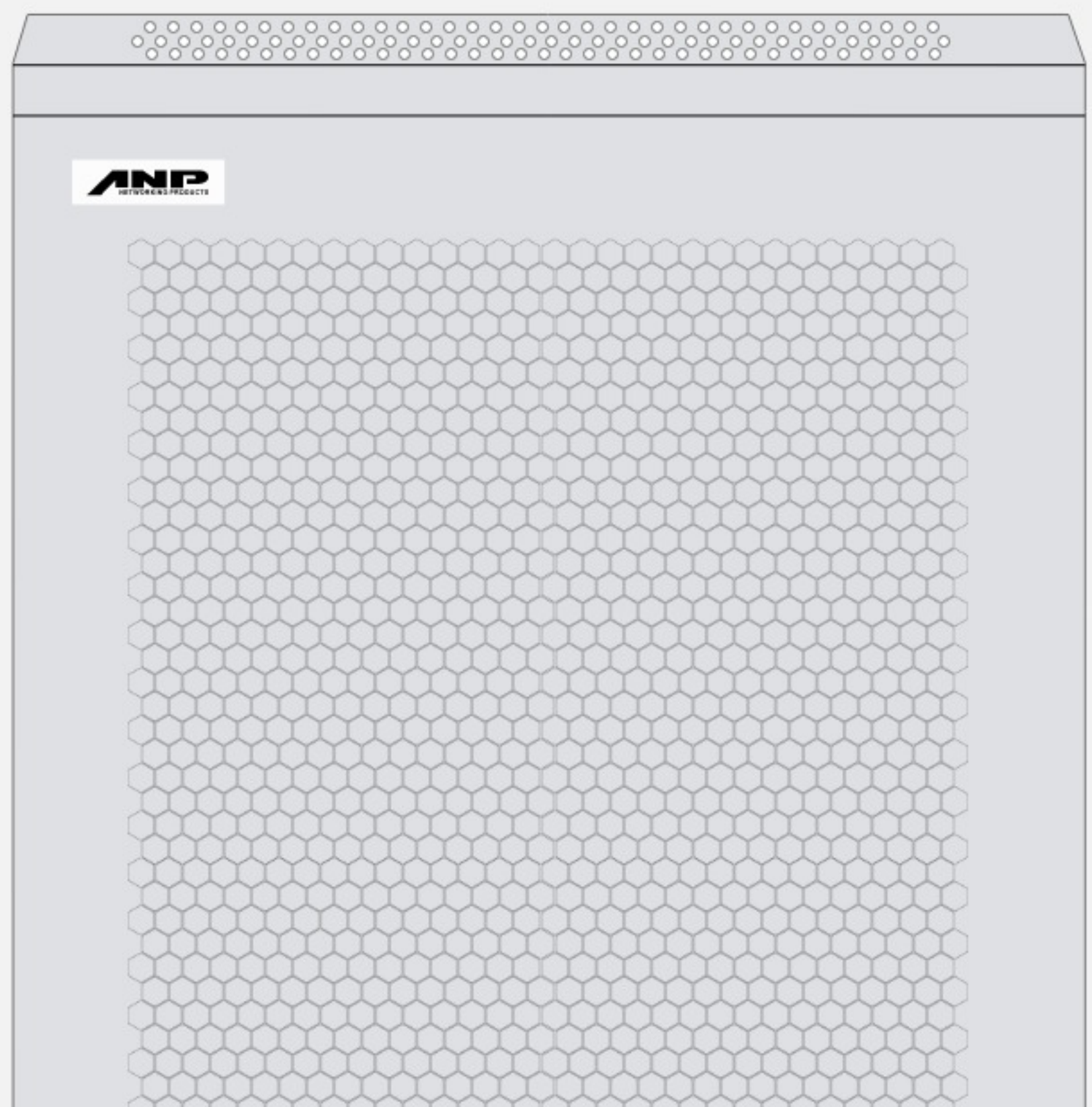

Mounting profile : 2.0mm
Mounting angle : 1.5mm
Others : 1.2mm

Several lockable cable entry on top cover and bottom panel with adjustable sizes.



Zinc alloy spring lock, easy to use, durable and wear-resistant.

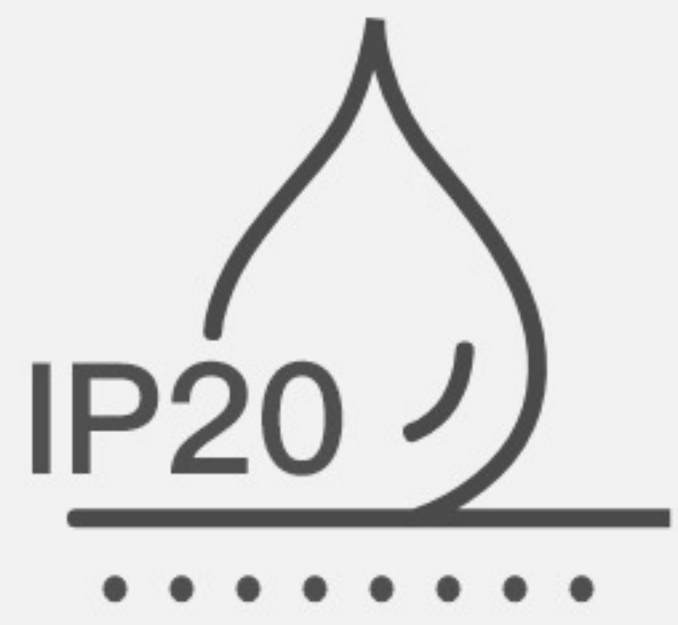

Loading Capacity 800kgs
(with adjustable feet)

SPCC
cold
rolled steel

Fan Unit (Optional)



Adjustable feet and heavy duty castors are available at the same time.



Adjustable mounting profile and mounting angle



Removable side panels, easy to install and maintain.



Surface

Degreasing, phosphoric,
powder coated or blue zinc plating

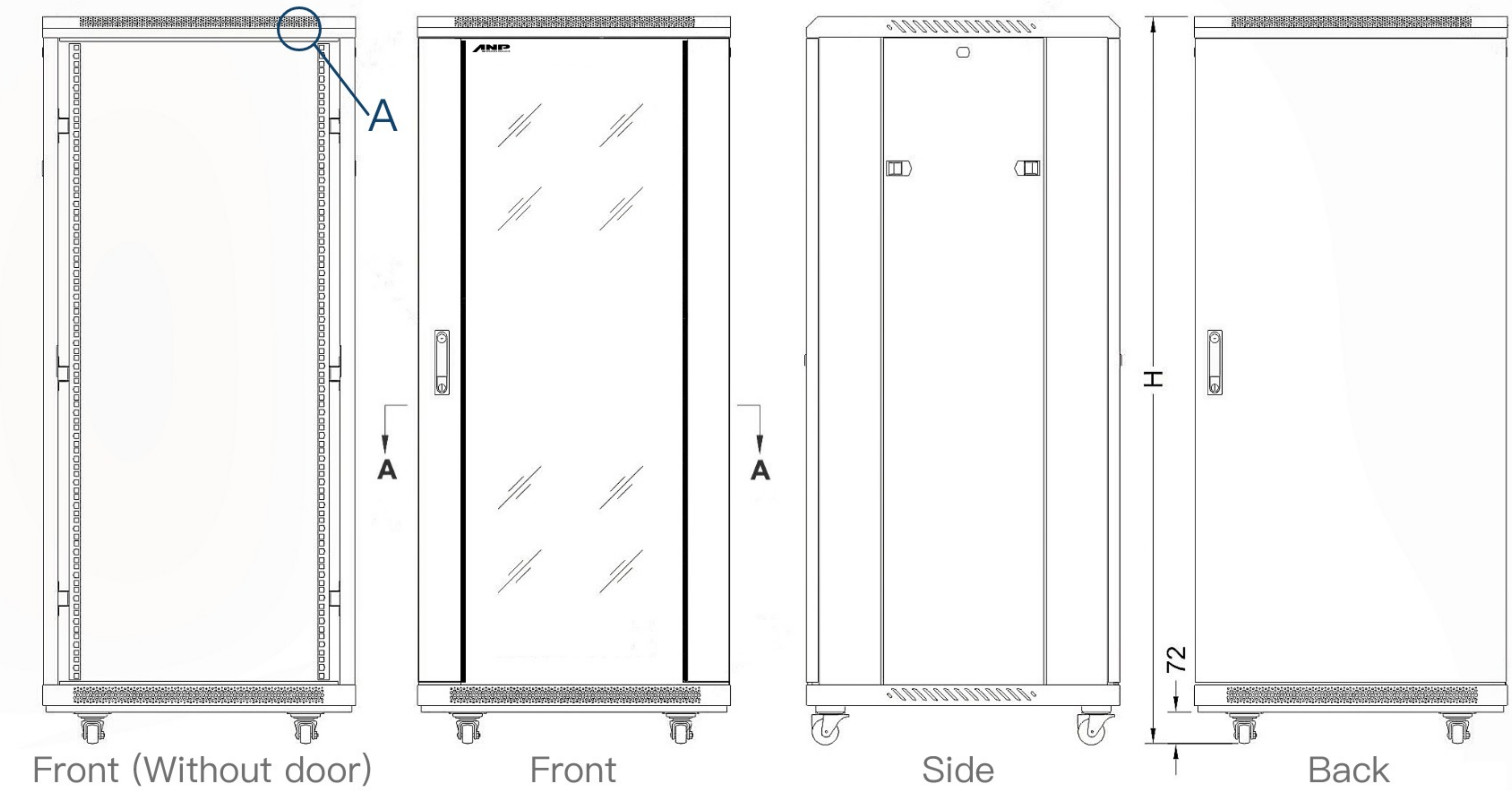

Front (Without door)

Front

Side

Back

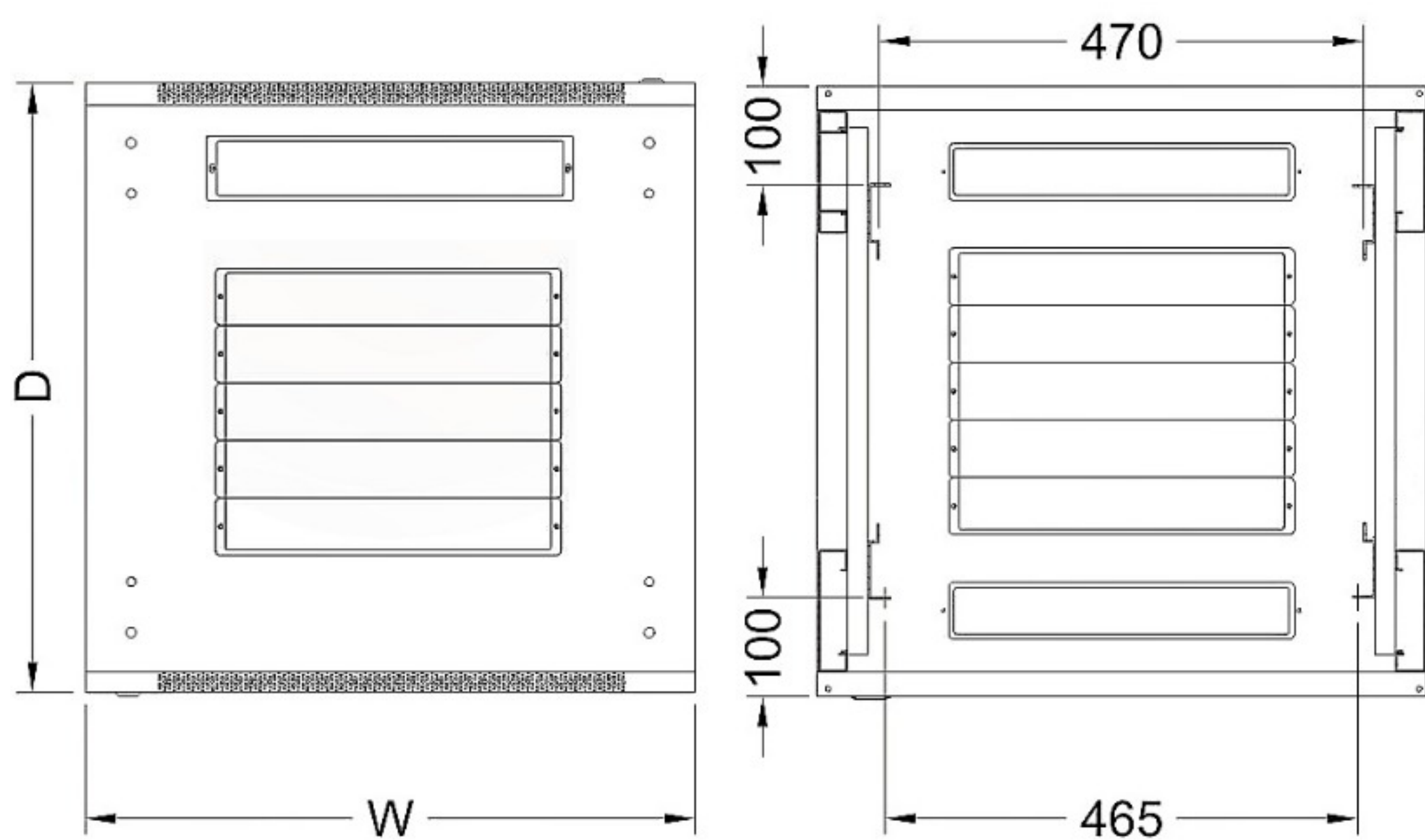

Top

A-A Section

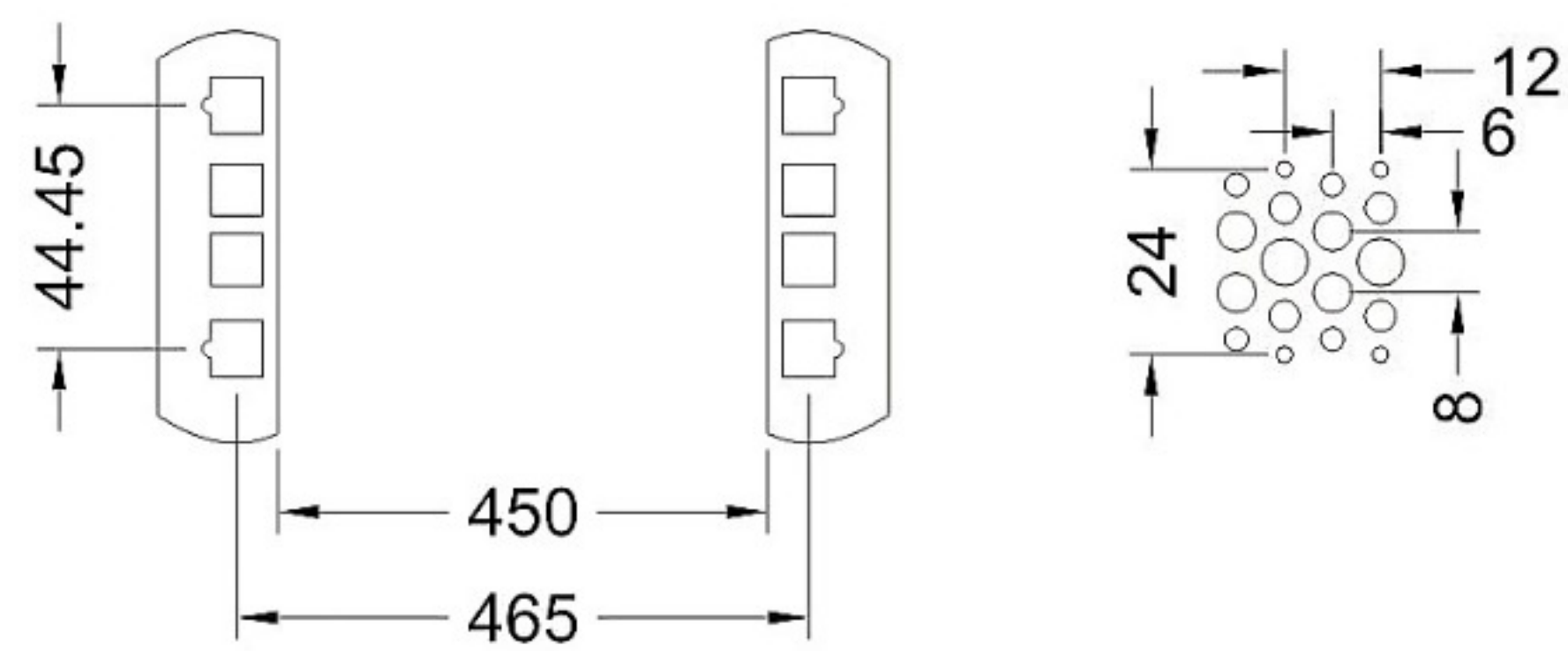

Mounting dimension

DETAIL A
SCALE 5:1

Glass Front/Metal Rear Door Cabinet

Choose Your Color



Gray



Black

Model No.	Capacity(U)	Width(mm)	Depth(mm)	Height(mm)
AP-CA8116622	22	600	600	1166
AP-CA8116822	22	600	800	1166
AP-CA8116022	22	600	1000	1166
AP-CA8116632	32	600	600	1610
AP-CA8116832	32	600	800	1610
AP-CA8116032	32	600	1000	1610
AP-CA8116642	42	600	600	2055
AP-CA8116842	42	600	800	2055
AP-CA8116042	42	600	1000	2055

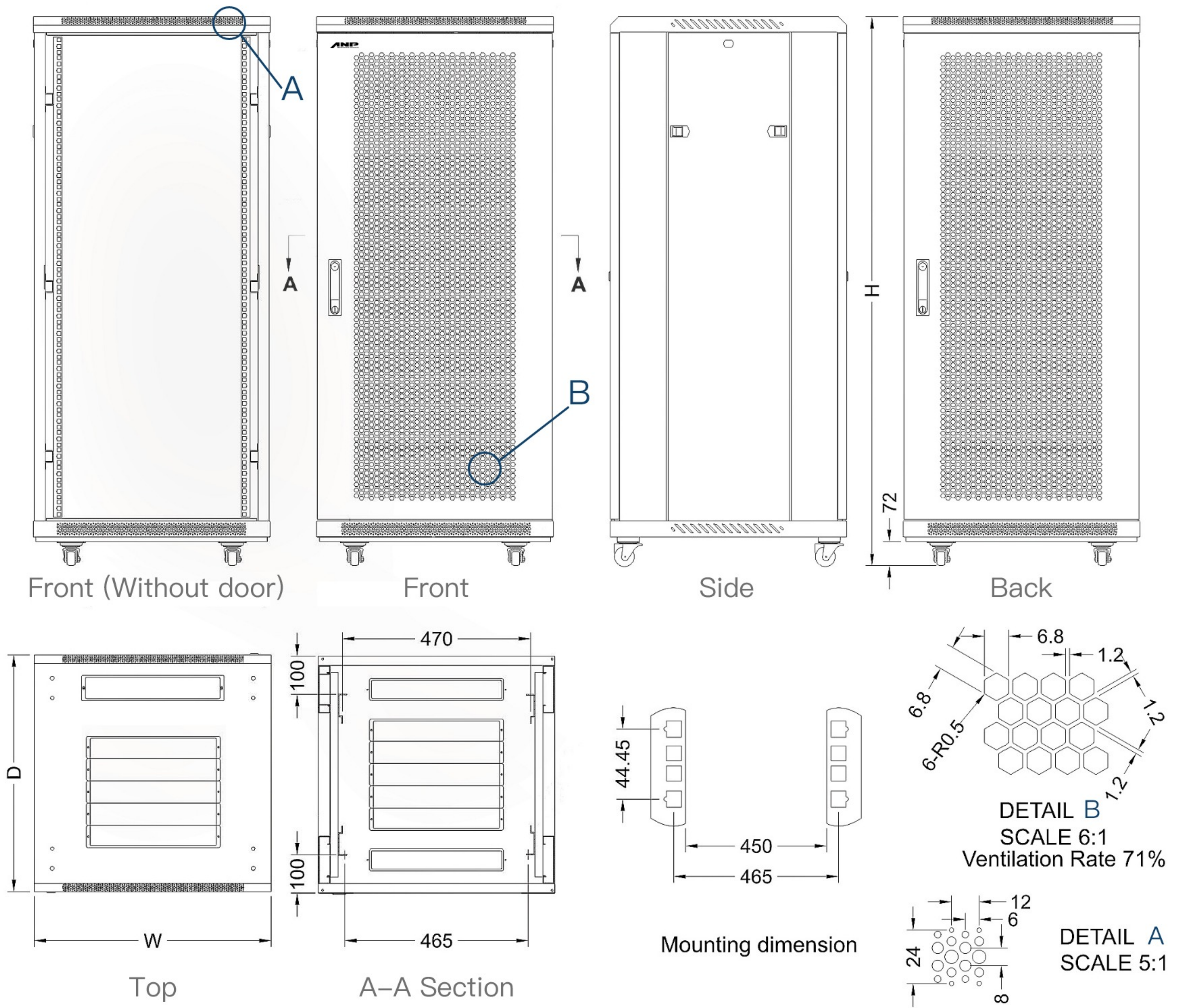

Vented Front/Rear Door Cabinet

Choose Your Color



Gray

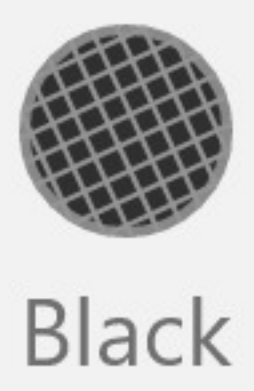

Black

Model No.	Capacity(U)	Width(mm)	Depth(mm)	Height(mm)
AP-CA8226622	22	600	600	1166
AP-CA8226822	22	600	800	1166
AP-CA8226022	22	600	1000	1166
AP-CA8226632	32	600	600	1610
AP-CA8226832	32	600	800	1610
AP-CA8226032	32	600	1000	1610
AP-CA8226642	42	600	600	2055
AP-CA8226842	42	600	800	2055
AP-CA8226042	42	600	1000	2055

FTTH Networking Cabinet



Comply with ANSI / EIA RS-310-D 、 IEC297-2 、 DIN41491PART1 、 DIN41494 ; PART7 、 GB/T3047.2-92

Vertical Cable Management

*default at front



Double door design on the back



Vertical Fiber/Cable Spool

*default at Back



Cable management and fiber/cable spool
can be reversed front to back

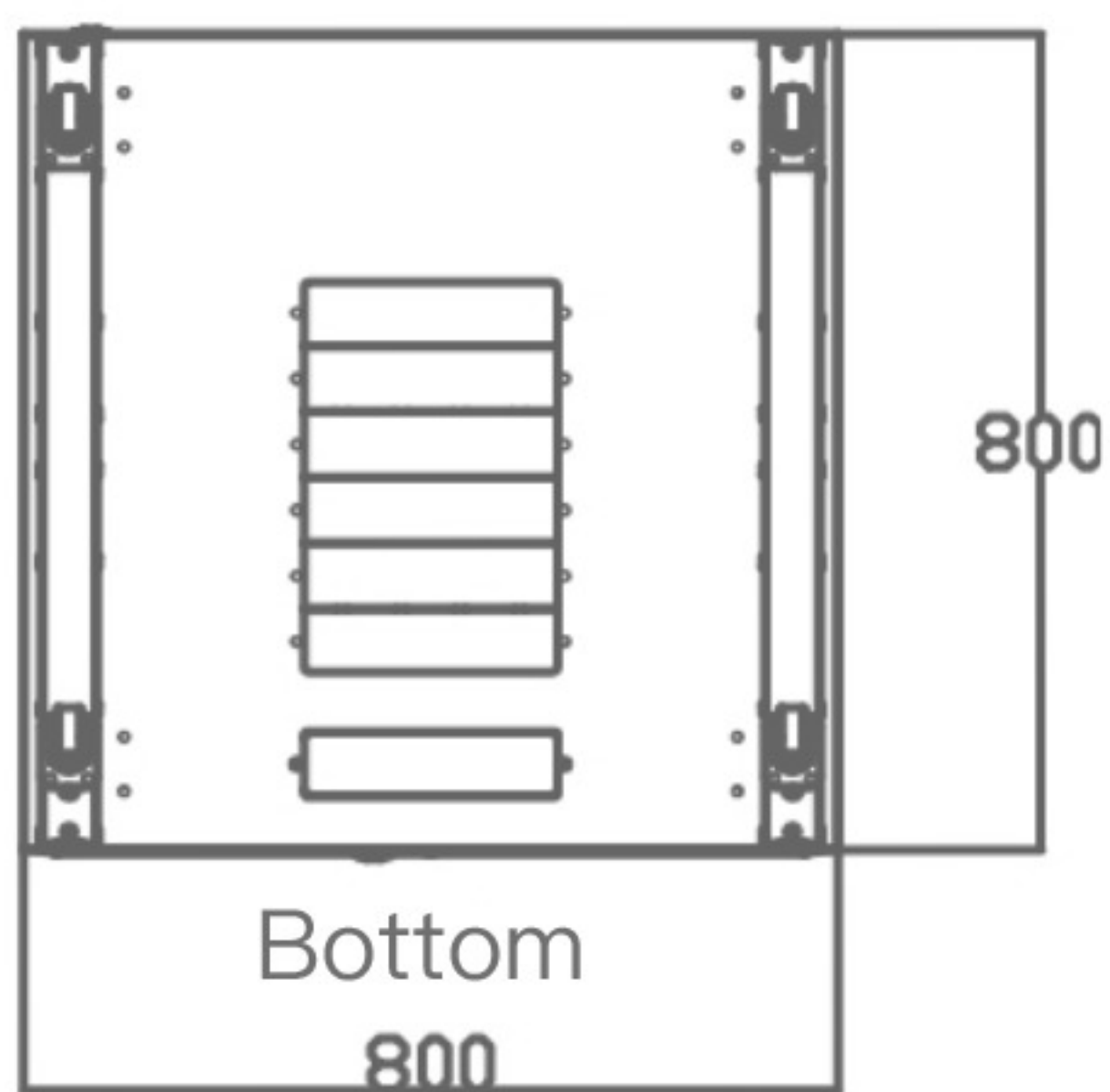
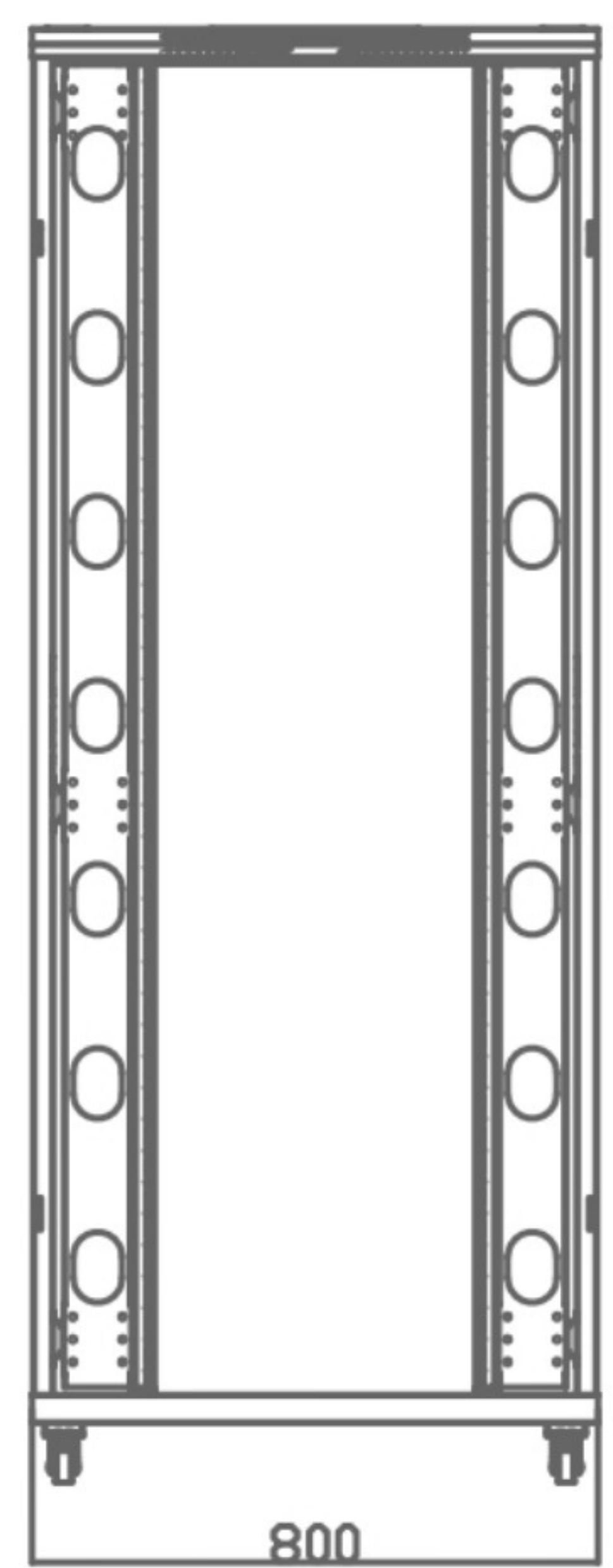
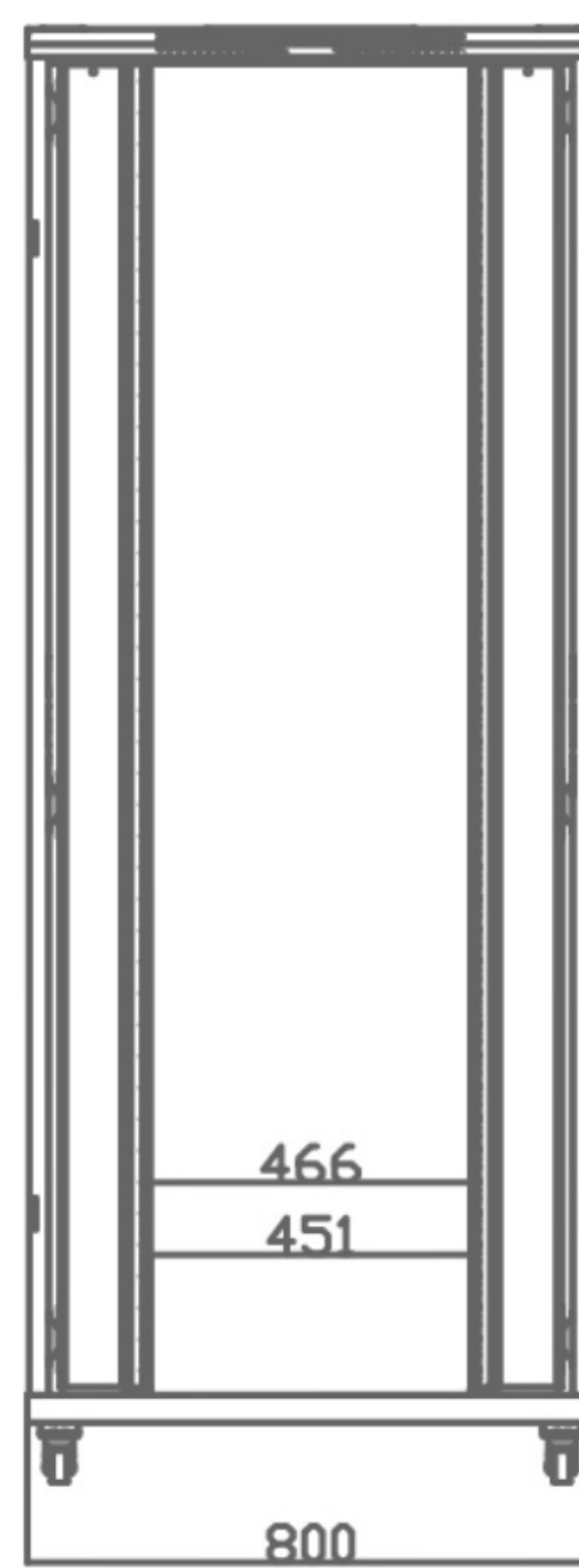
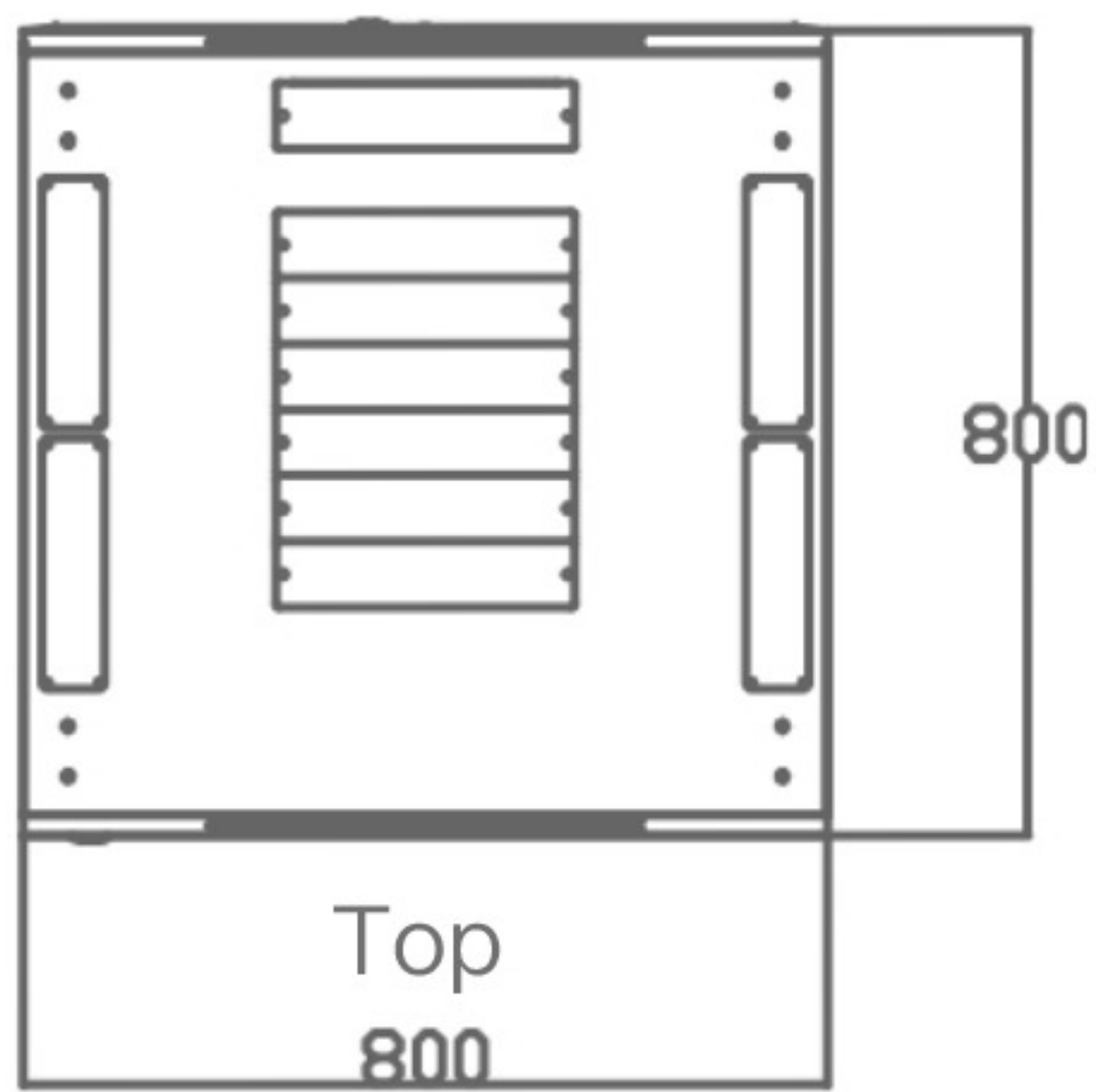
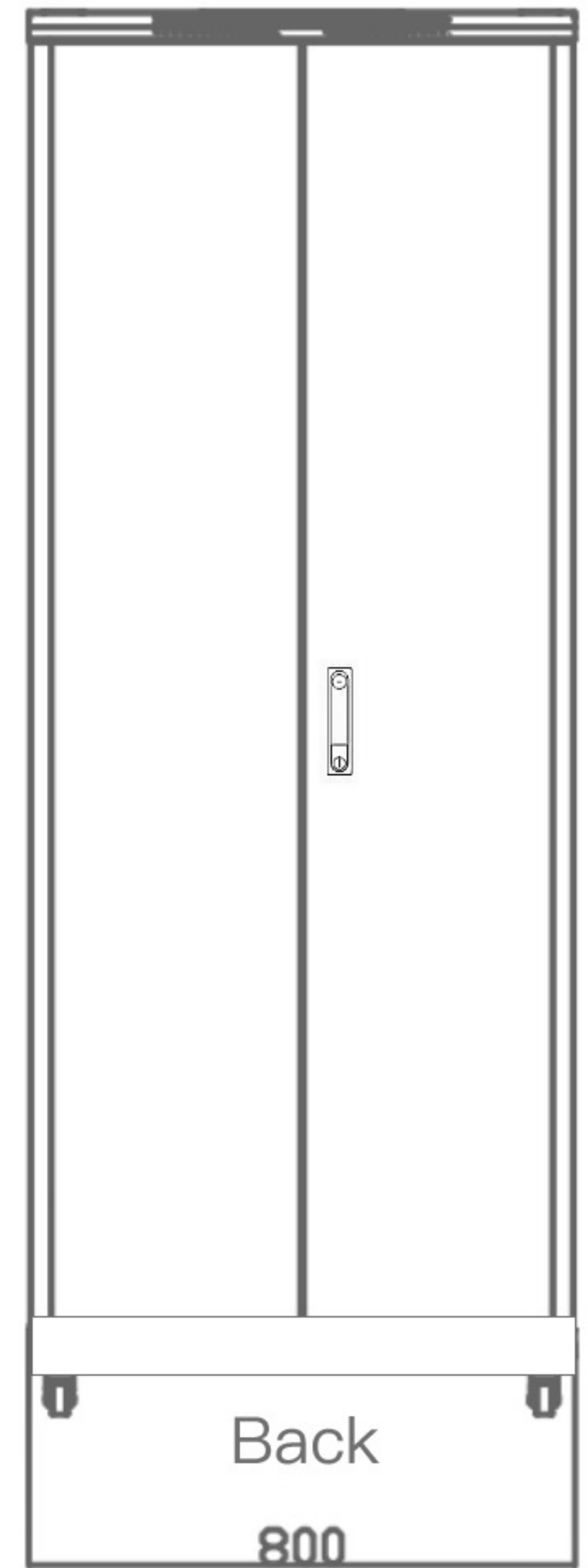
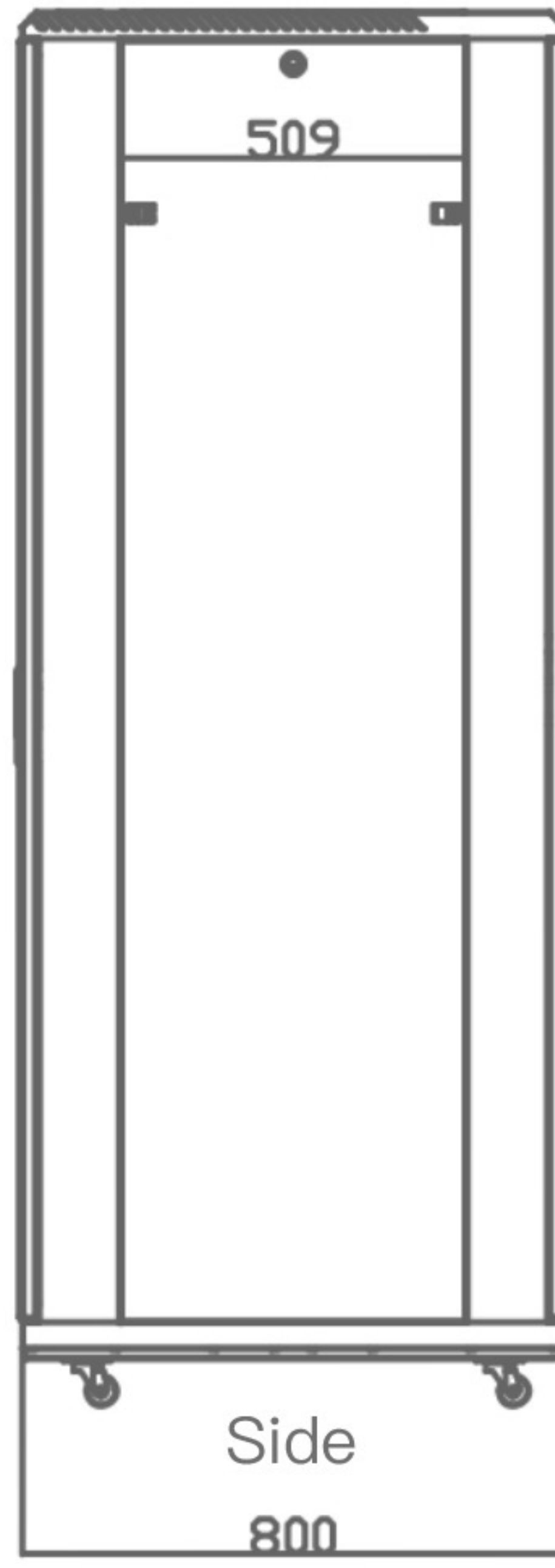
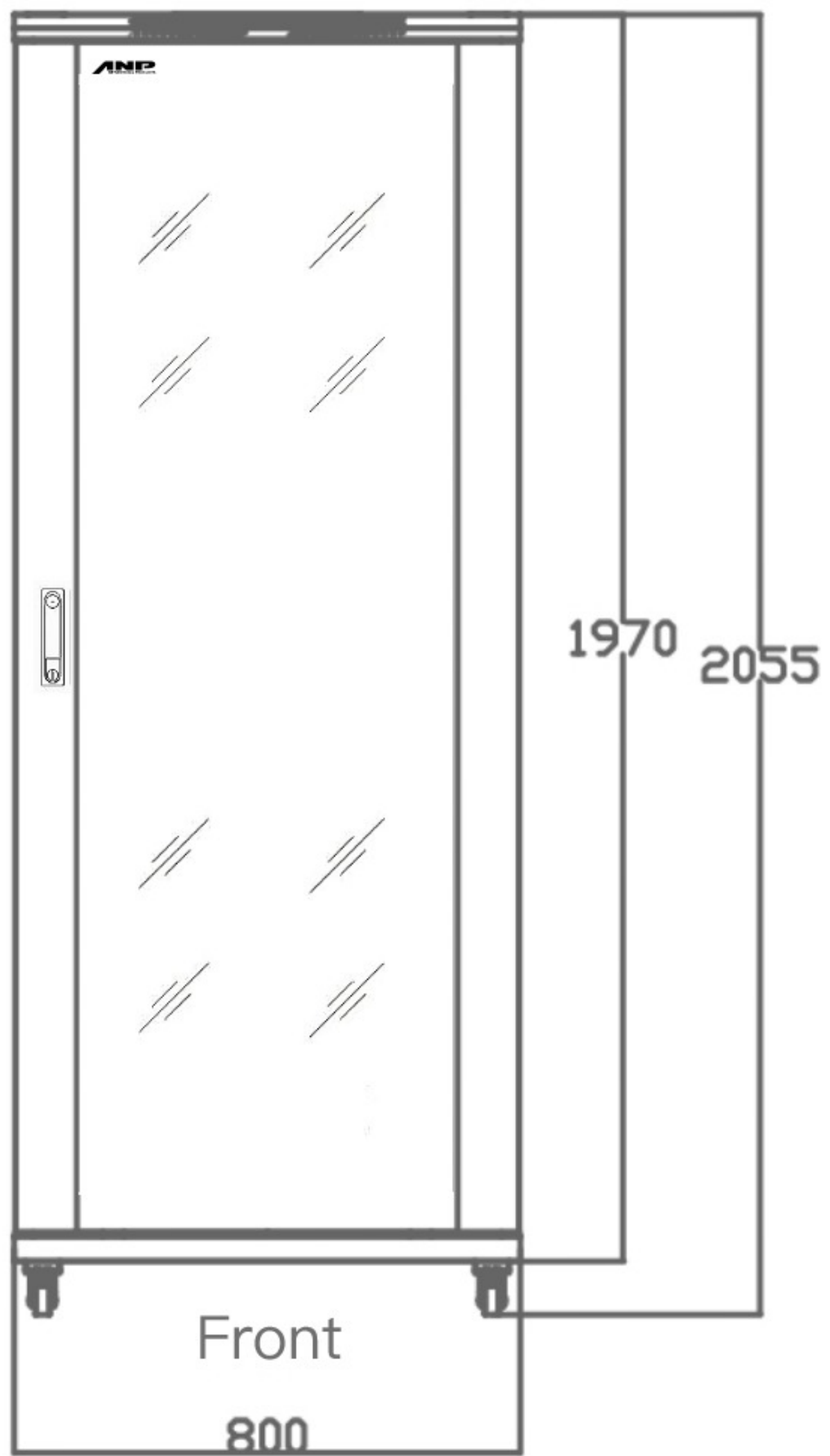

Front (Without door)

Back (Without door)

Glass Front/Double Metal Rear Door
800 mm FTTH Network Cabinet

Choose Your Color



Gray



Black

Model No.	Capacity(U)	Width(mm)	Depth(mm)	Height(mm)
AP-CA8118842	42	800	800	2055

Wall Mount Single Section Cabinet

4U 6U 9U 12U 15U

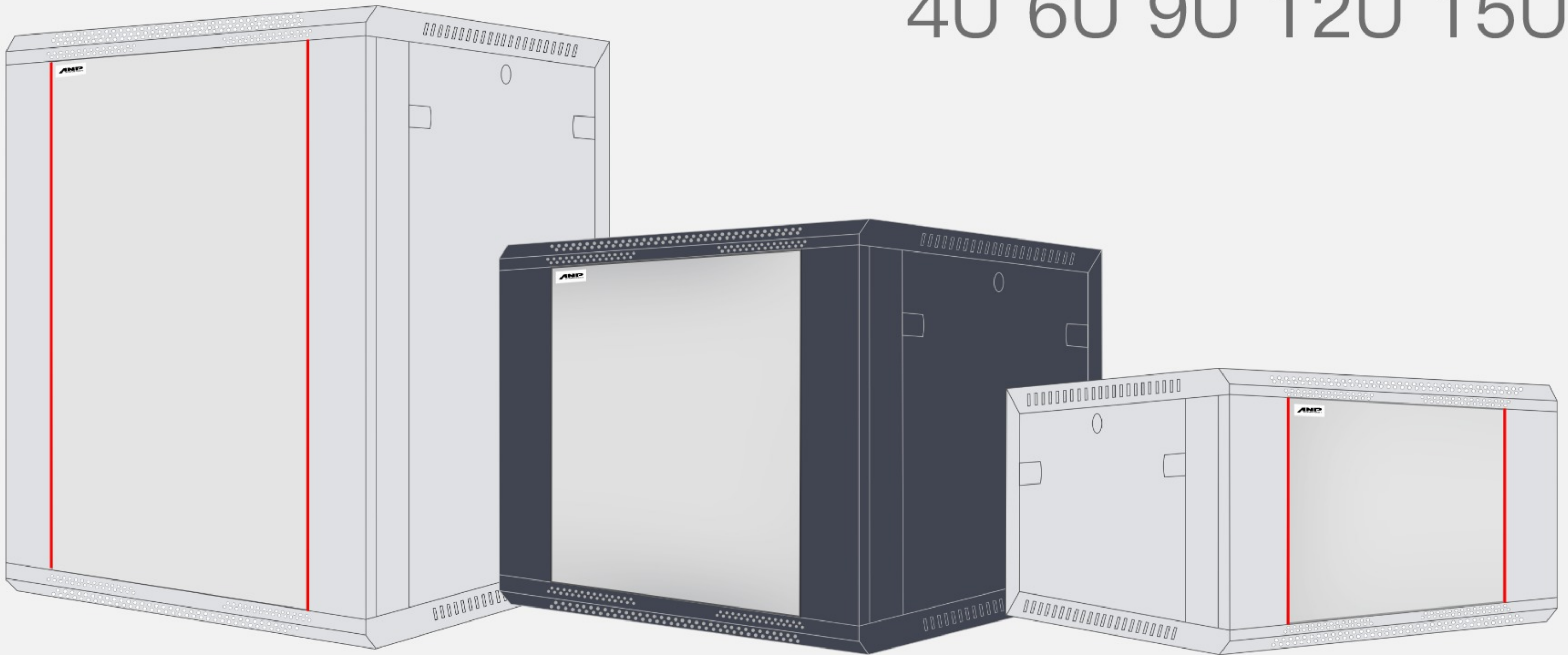

Comply with ANSI / EIA RS-310-D 、 IEC297-2 、 DIN41491PART1 、 DIN41494 ; PART7 、 GB/T3047.2-92

Exquisite design with precise dimension and craftsmanship.

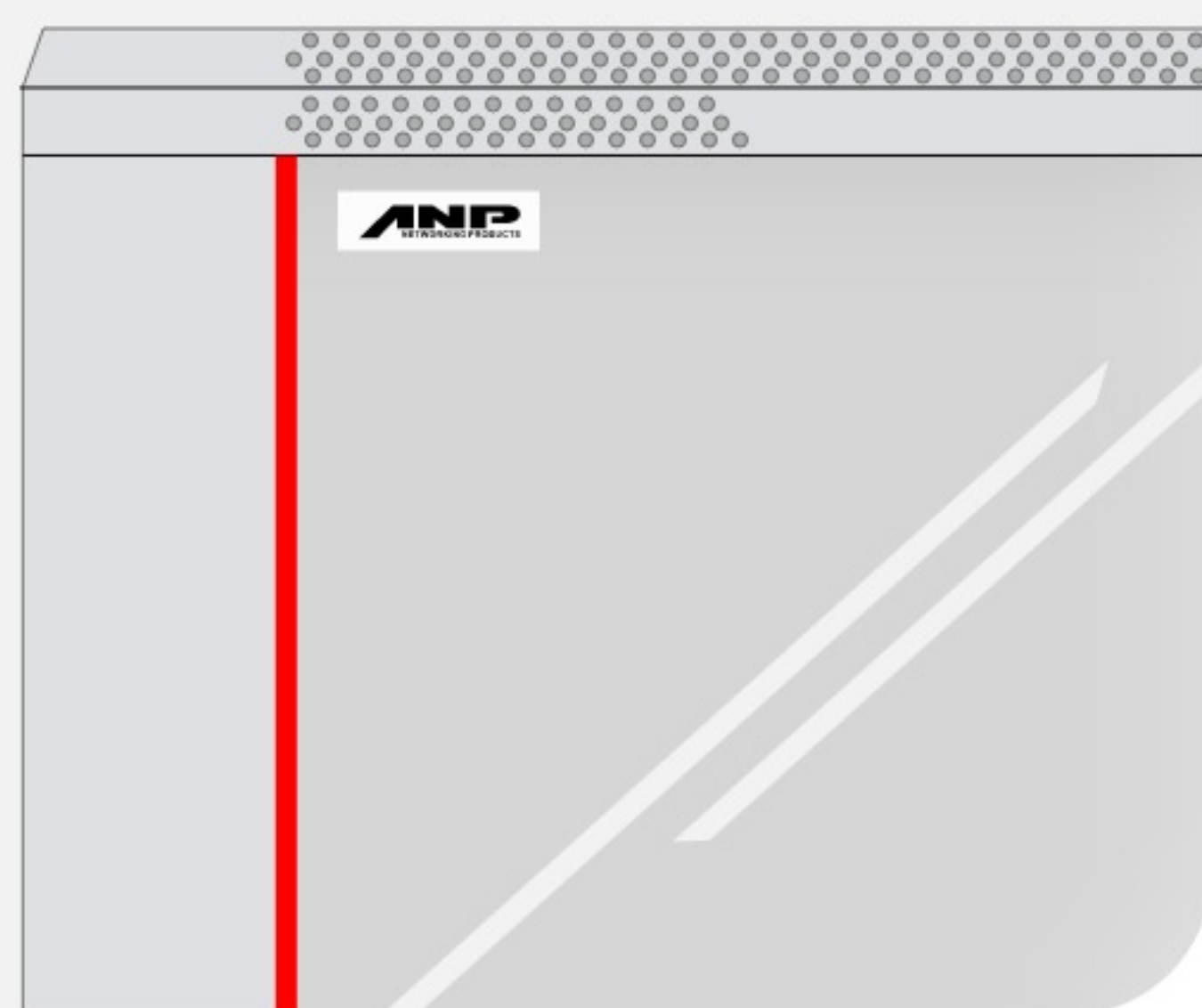

Mounting profile : 2.0mm

Others : 1.2mm

Removable side panels.



Degreasing, phosphoric,
powder coated or blue zinc plating



Lockable 120mm fan holes and cable entry.



SPCC
cold
rolled steel



Loading Capacity 60kgs

Welded frame, reliable structure.



With mounting panel, its more easy for one person to Install to wall.



Inside fixation by nuts to avoid accident.



Zinc alloy round lock.



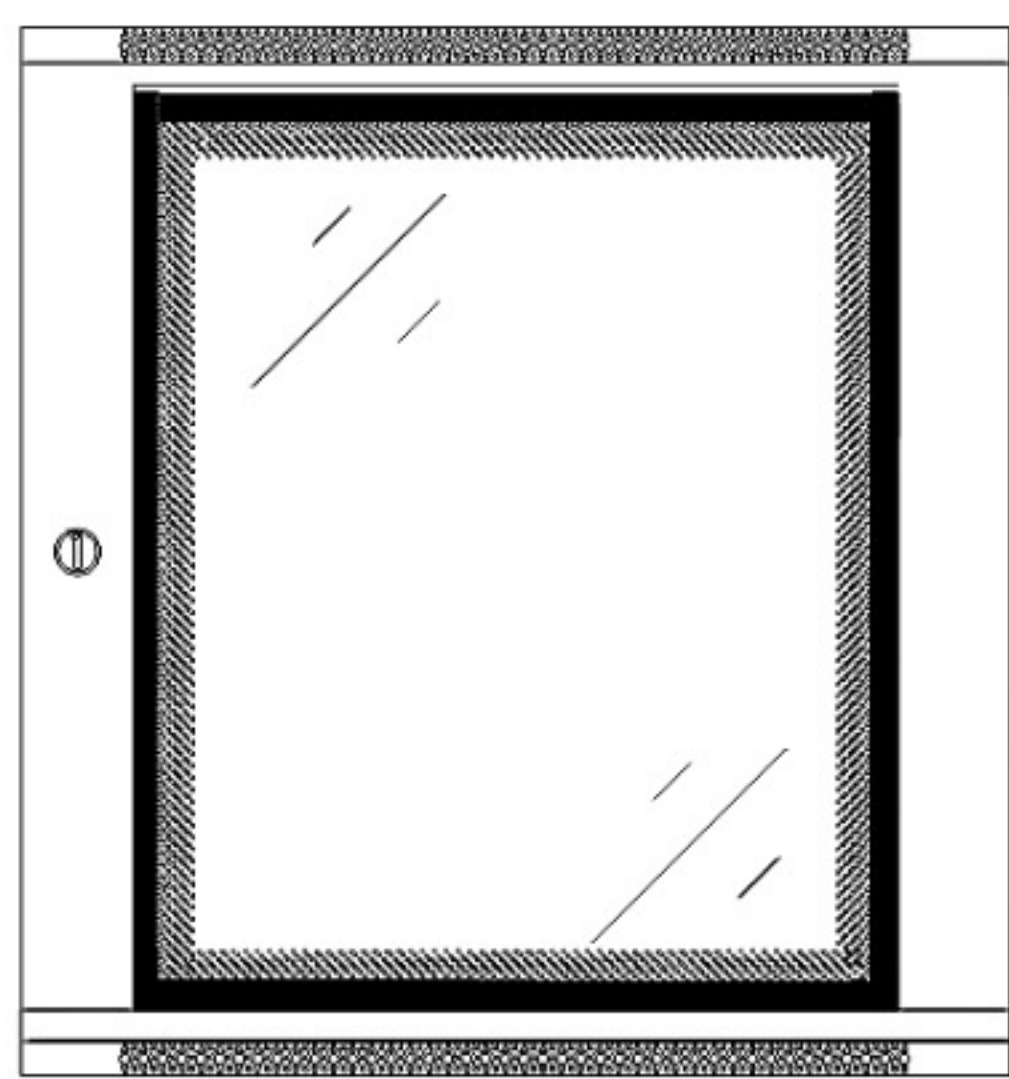
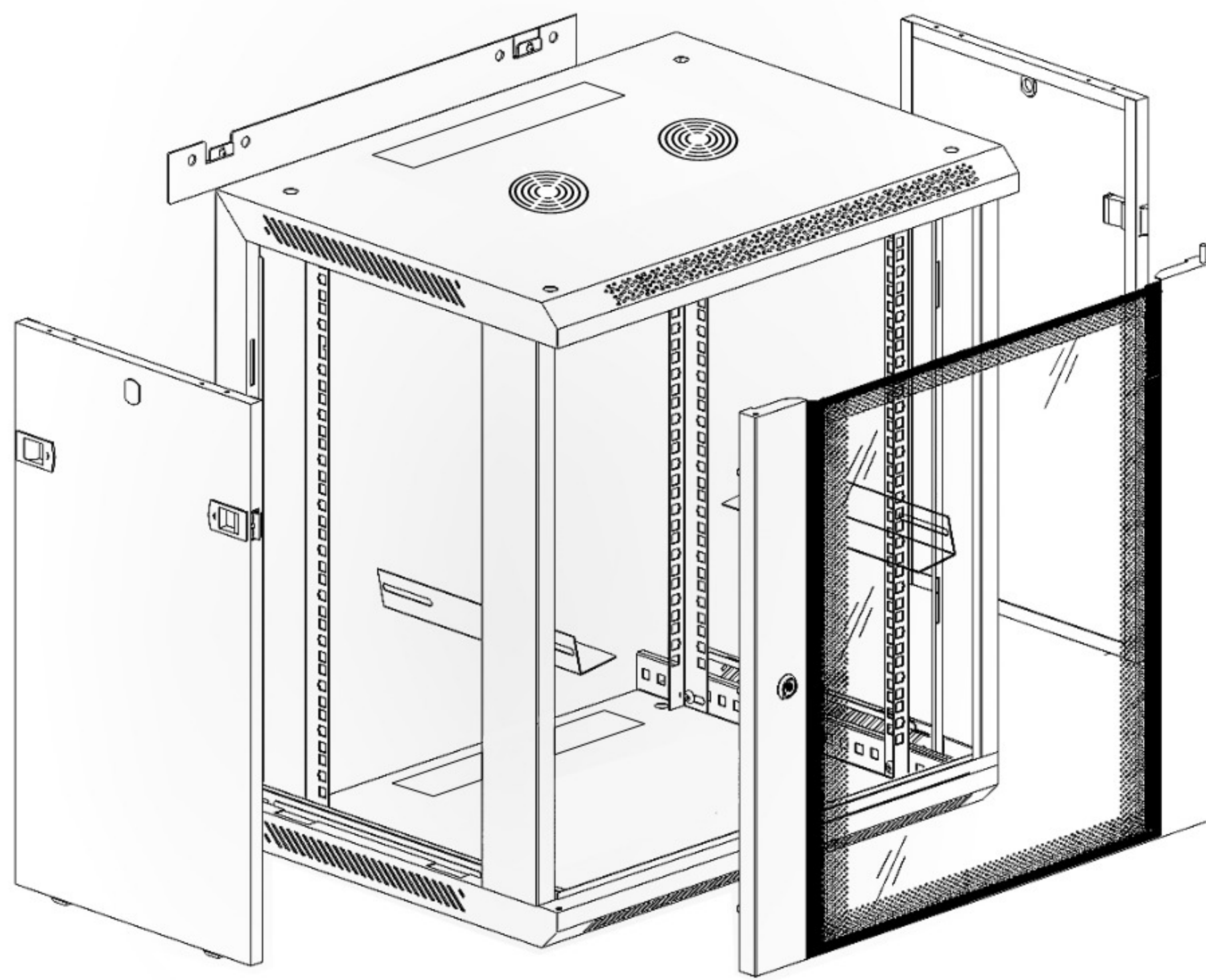

Front(toughened glass door)

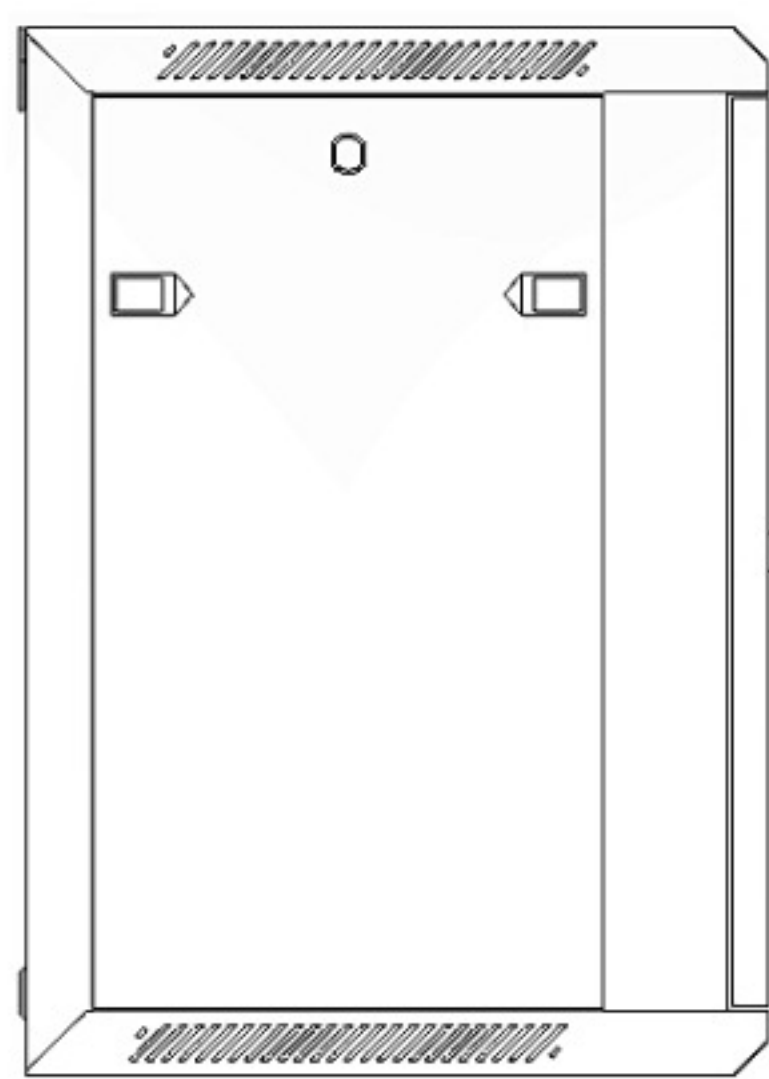

Side

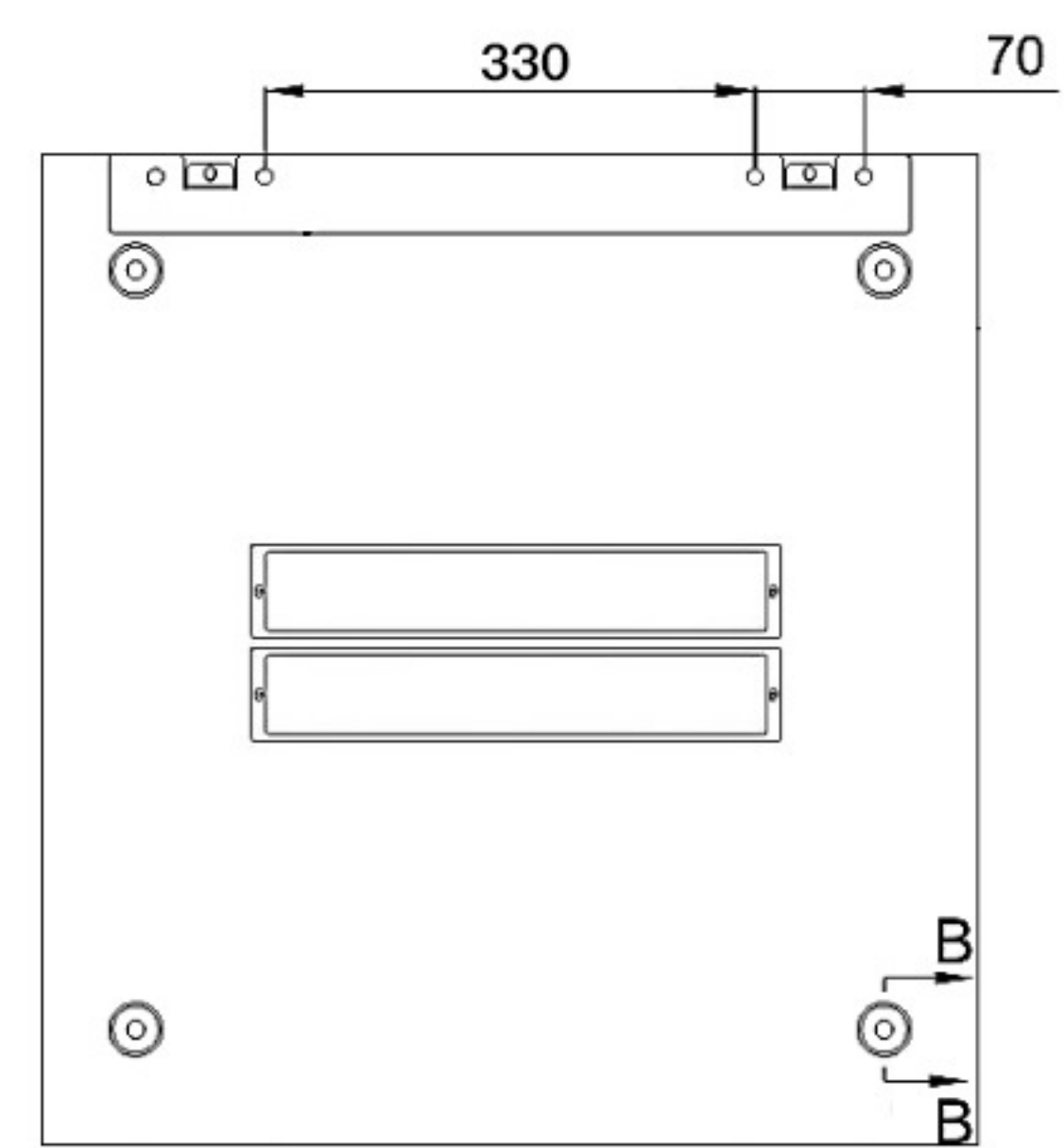

Back(wall-mounted hole size)

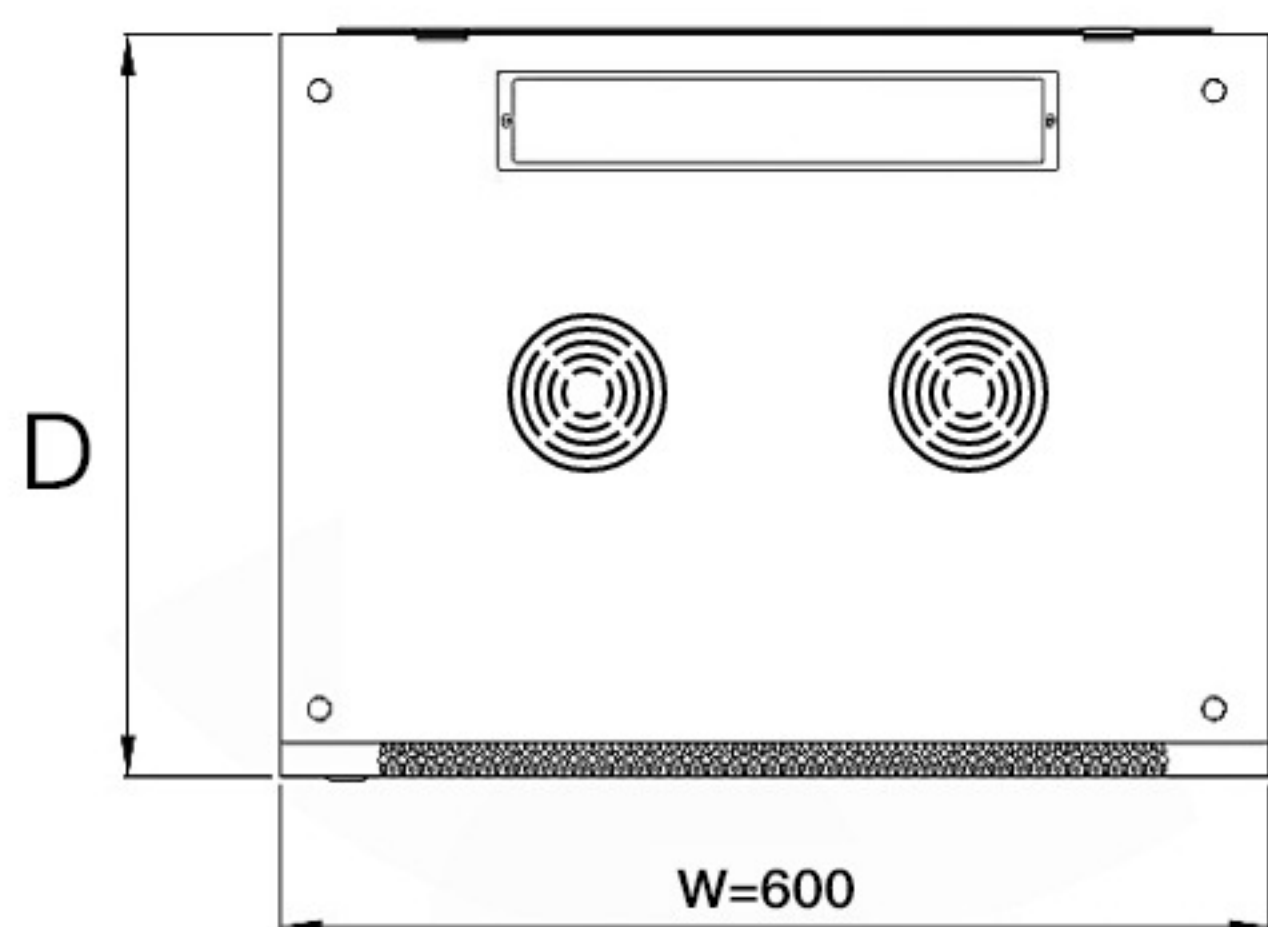

Top

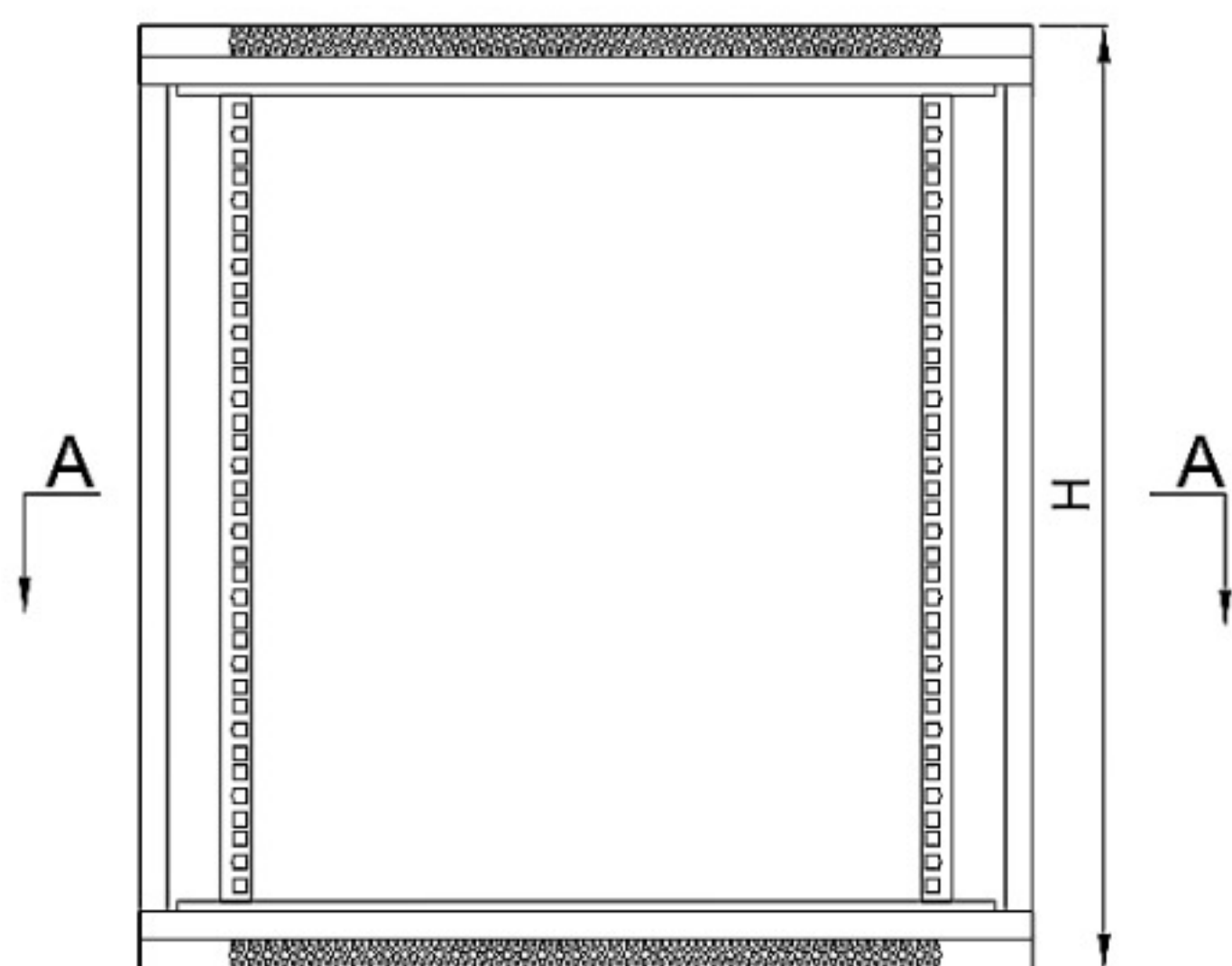

Front(without front door)

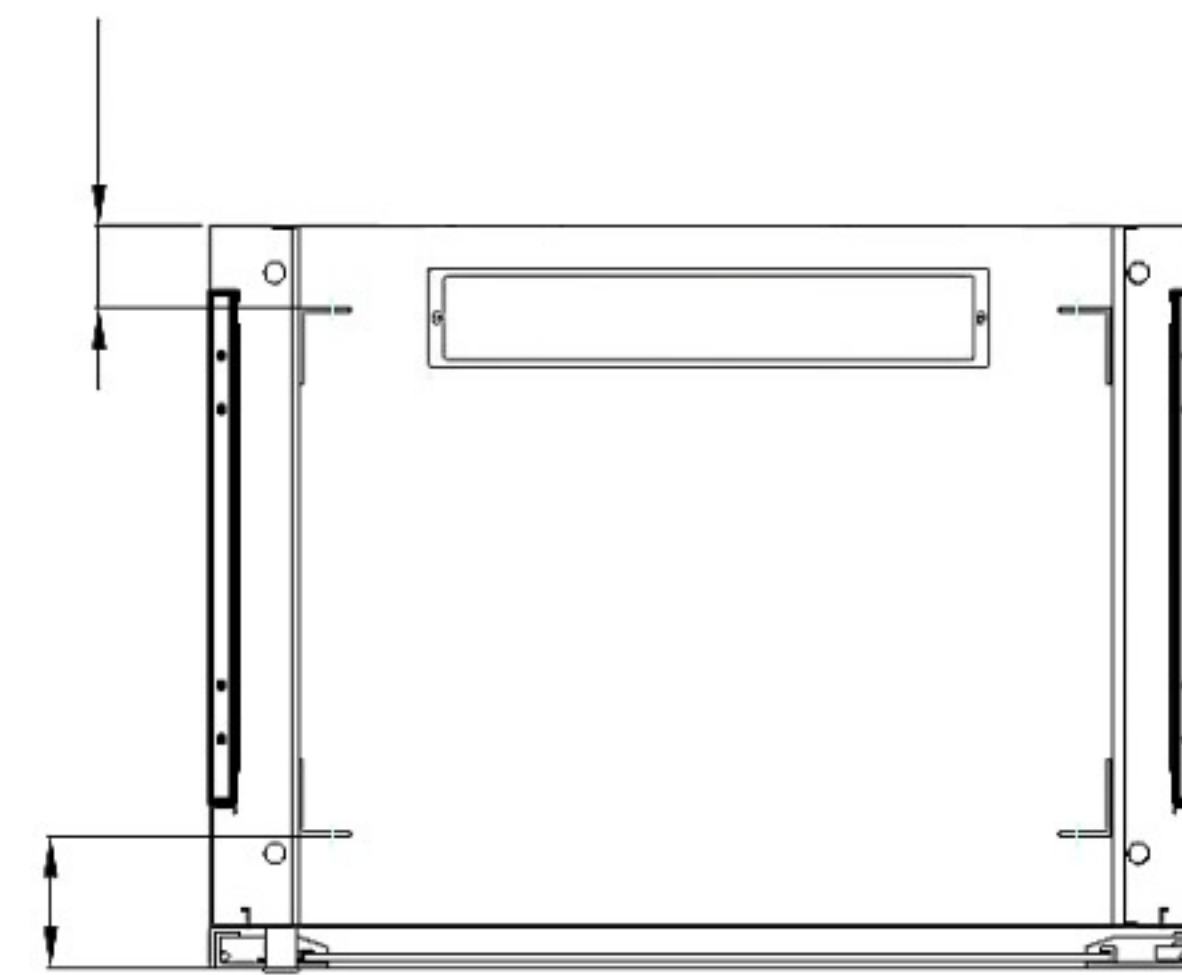

A-A Section

600mm
Wall Mount Single Section Cabinet

Choose Your Color



Gray



Black

Model No.	Capacity(U)	Width(mm)	Depth(mm)	Height(mm)
AP-WA6116404	4	600	450	279
AP-WA6116406	6	600	450	368
AP-WA6116409	9	600	450	501
AP-WA6116609	9	600	600	501
AP-WA6116612	12	600	600	635
AP-WA6116615	15	600	600	768

Wall Mount Bracket



Material: SPCC cold rolled steel t1.5

Surface finish: Degreasing, phosphoric, powder coated

Color: AP-WMB-□UG AP-WMB-□UK

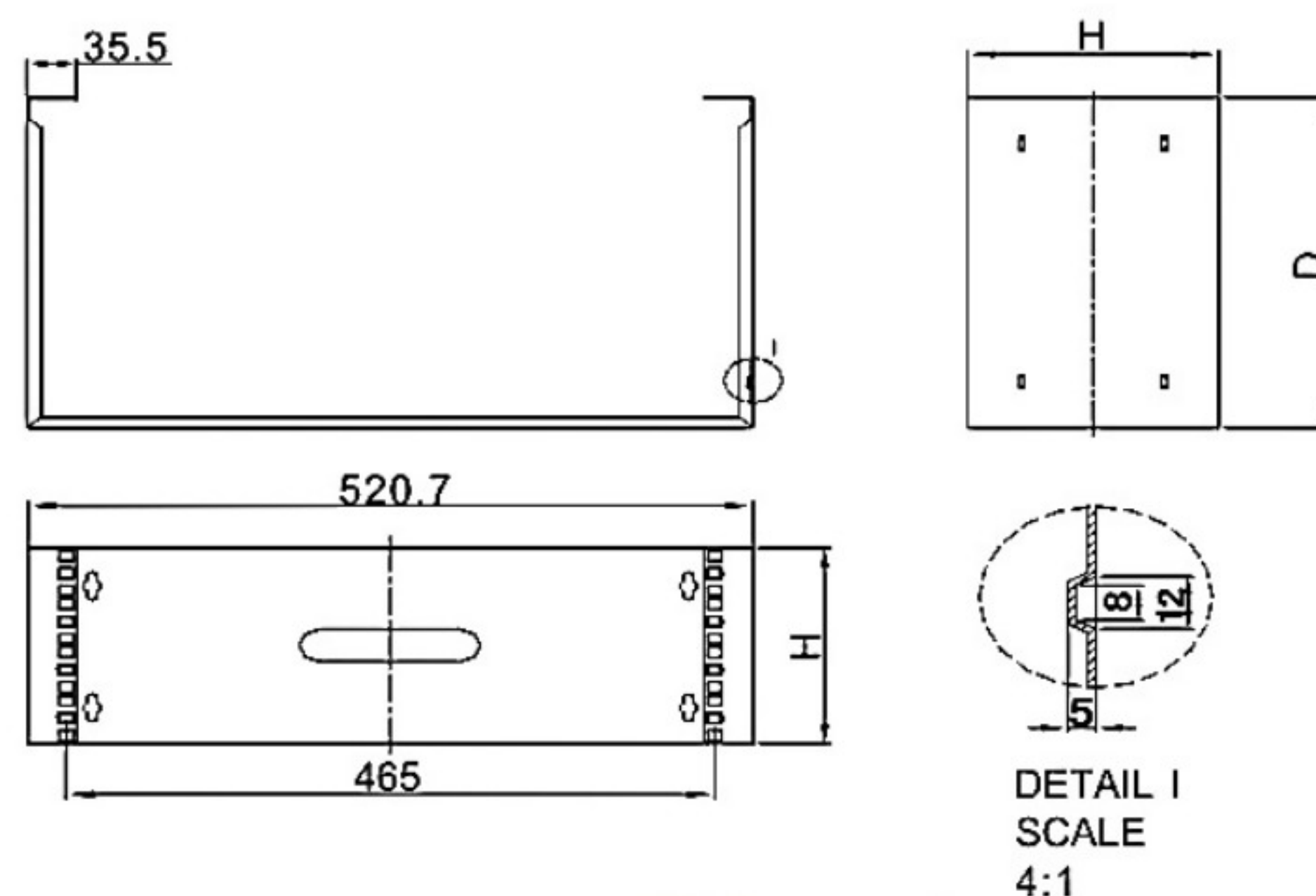

Model No.	Capacity(U)	Width(mm)	Depth(mm)	Height (mm)
AP-WMB-2U	2	521	305	90
AP-WMB-4U	4	521	305	180

Fixed Shelf



Material: SPCC cold rolled steel t1.2

Surface finish: Degreasing, phosphoric, powder coated

Loading Capacity: 60kgs

Color: AP-SAS□□G AP-SAS□□K

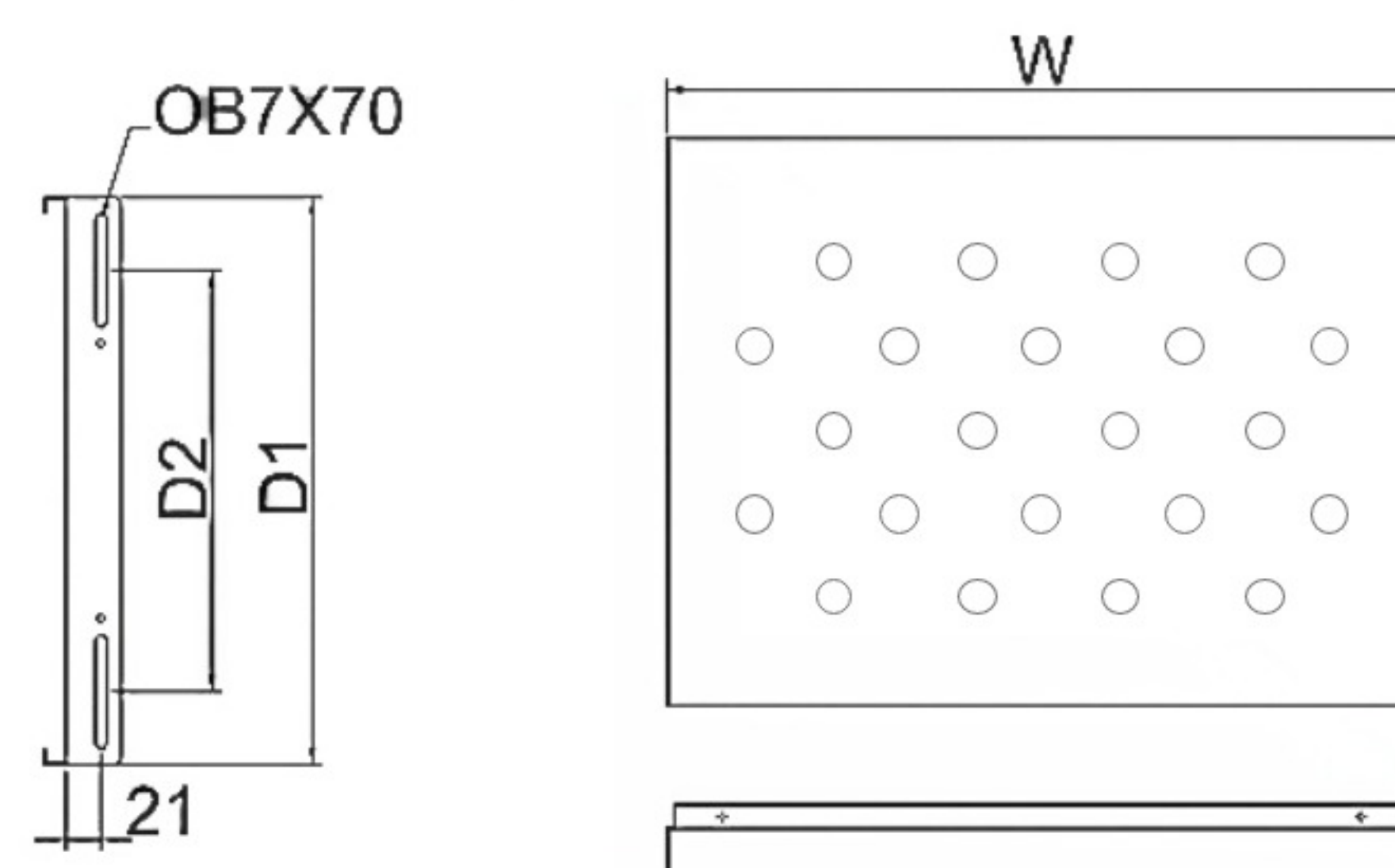

Model No.	Specification	Dimension(mm)				Use
		Width	Depth1	Depth2	Height	
AP-SAS66	60 Fixed Shelf	487	350	260	45	For ANP 600mm depth cabinet
AP-SAS68	80 Fixed Shelf	487	550	460	45	For ANP 800mm depth cabinet
AP-SAS60	100 Fixed Shelf	487	730	640	45	For ANP 1000mm depth cabinet

Fixed Shelf with Mounting Ears

Material: SPCC cold rolled steel t1.2

Surface finish: Degreasing, phosphoric, powder coated

Loading Capacity: 40kgs

Color: AP-SA000G AP-SA000K

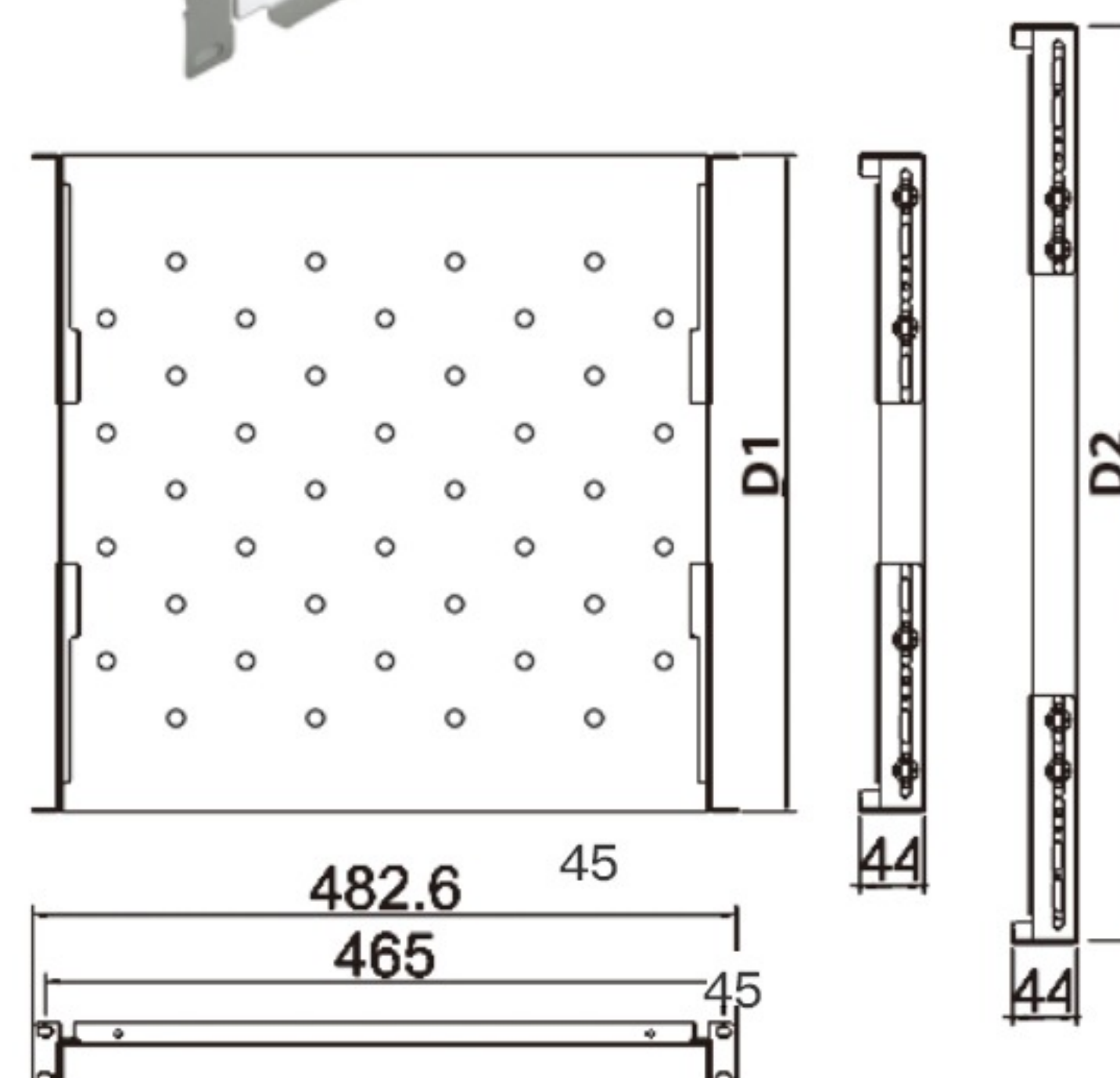

Model No.	Specification	Dimension(mm)				Use
		Width	Depth1	Depth2	Height	
AP-SA066	60 Fixed Shelf with extendable mounting ears	483	350	550	45	19" Standard, extendable from 350mm-550mm
AP-SA068	80 Fixed Shelf with extendable mounting ears	483	550	730	45	550mm-730mm
AP-SA060	100 Fixed Shelf with extendable mounting ears	483	730	910	45	730mm-910mm

Cantilever Shelf

Material: SPCC cold rolled steel t1.2

Surface finish: Degreasing, phosphoric, powder coated

Loading Capacity: 20kgs

Color: AP-SAC00G AP-SAC00K

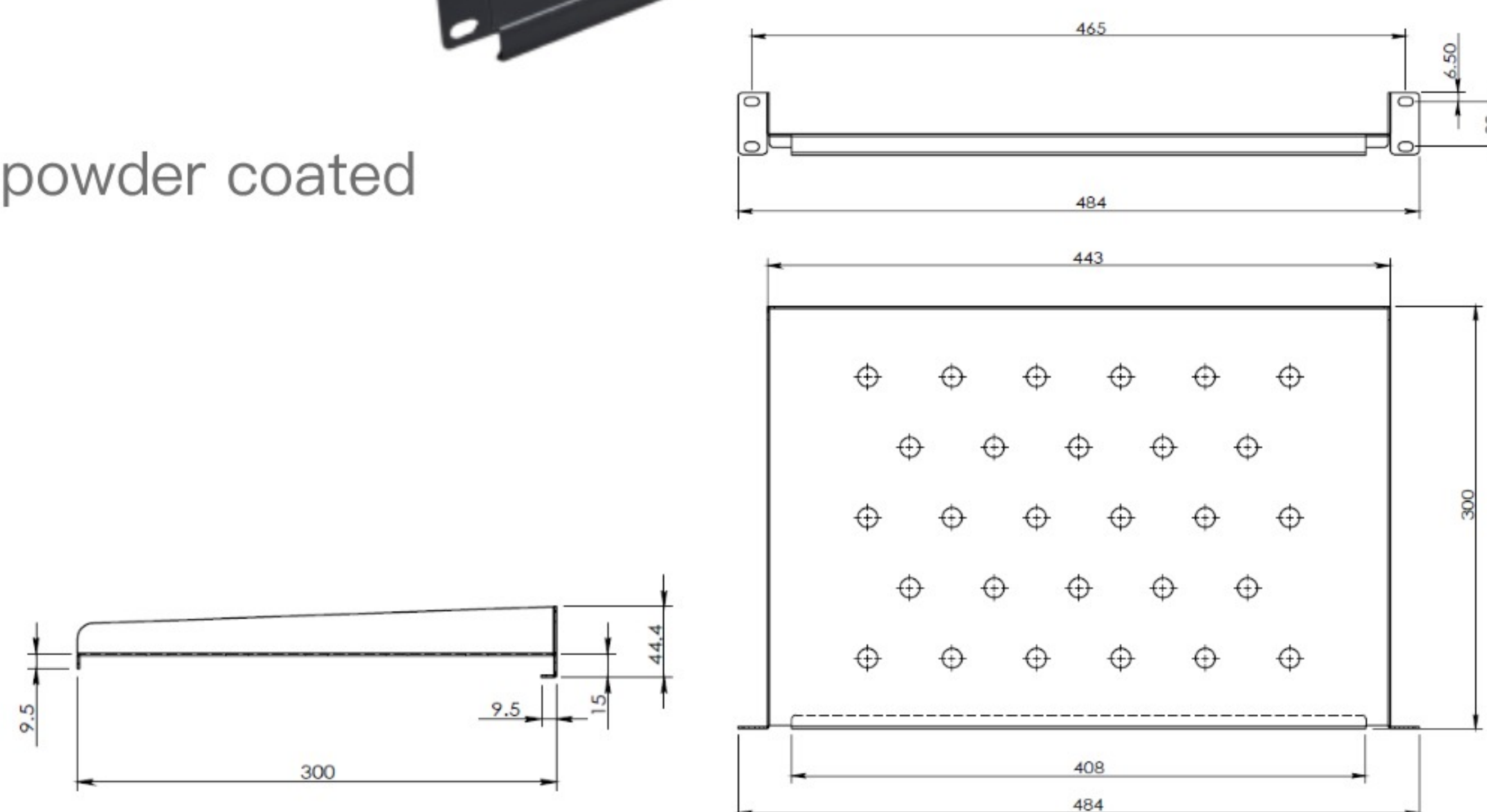
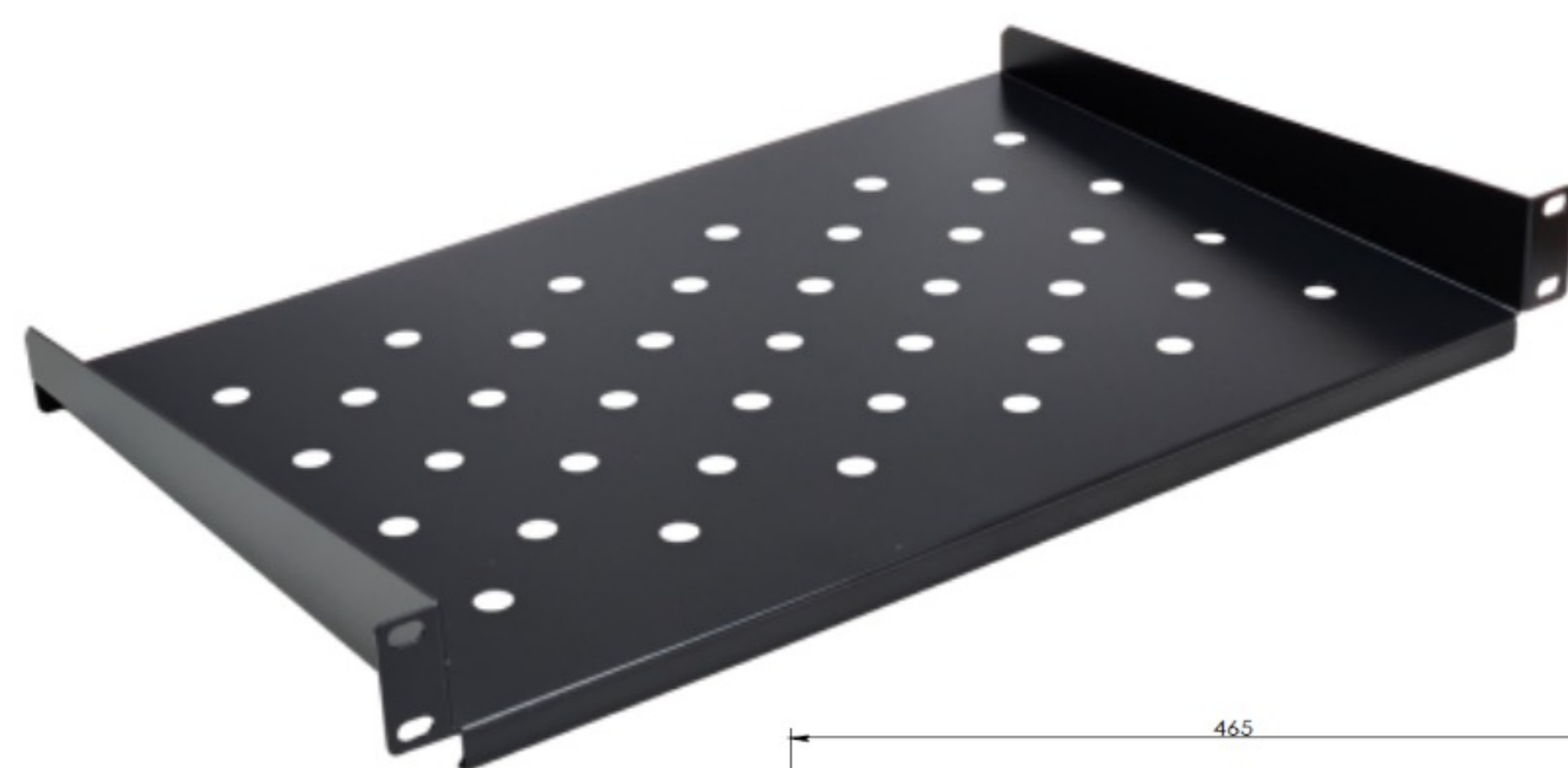

Model No.	Specification	Dimension(mm)			Use
		Width	Depth	Height	
AP-SAC24-1U	40 Cantilever Shelf	483	300	45	19" Standard
AP-SAC24-2U	60 Cantilever Shelf	483	300	88	19" Standard
AP-SAC26-2U	80 Cantilever Shelf	483	350	88	19" Standard

Sliding Shelf

Material: SPCC cold rolled steel t1.2

Surface finish: Degreasing, phosphoric, powder coated

Loading Capacity: 20kgs

Color: AP-SAUL00G AP-SAUL00K



▲ AP-SAUL26

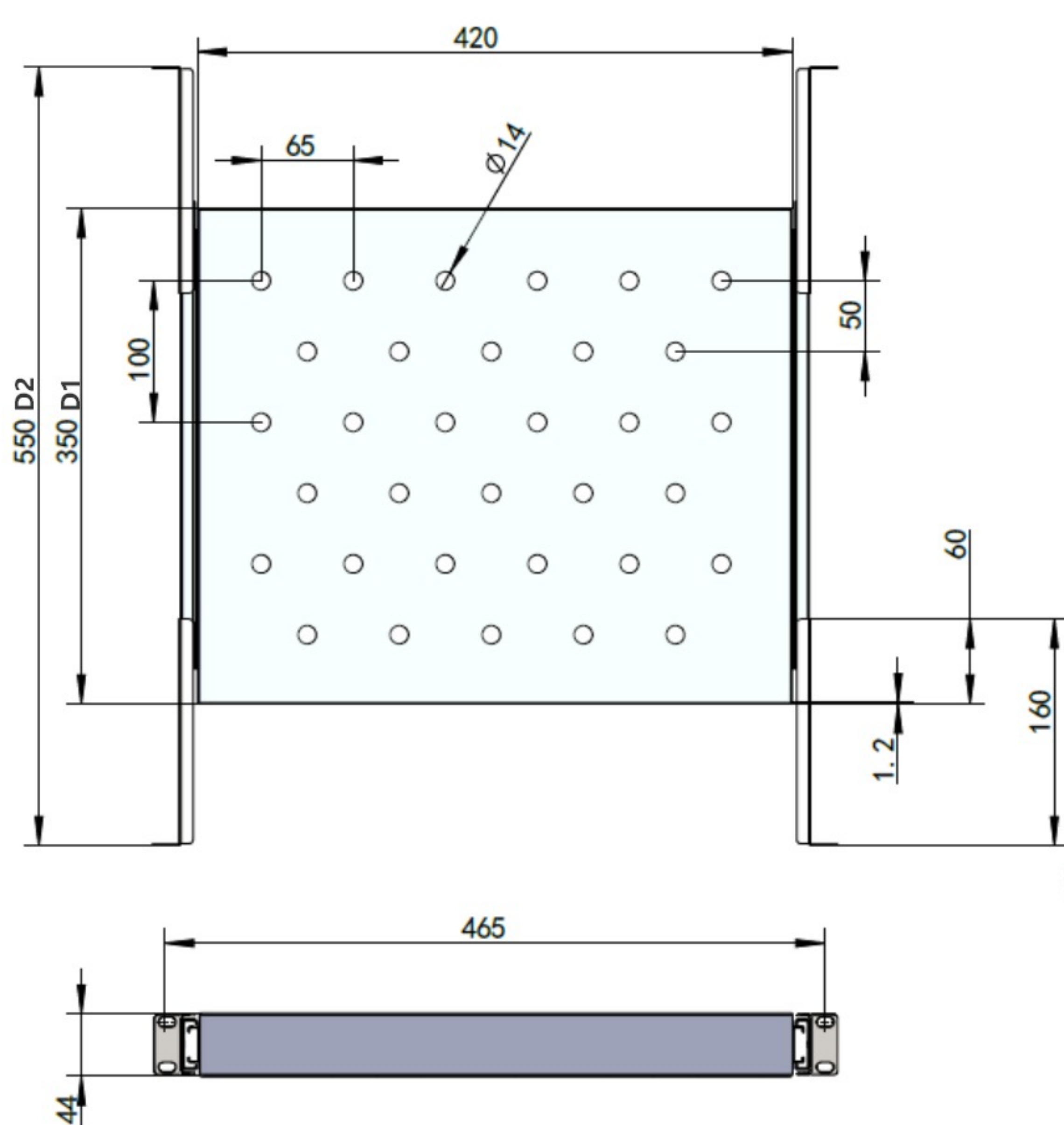

▲ AP-SAUL26

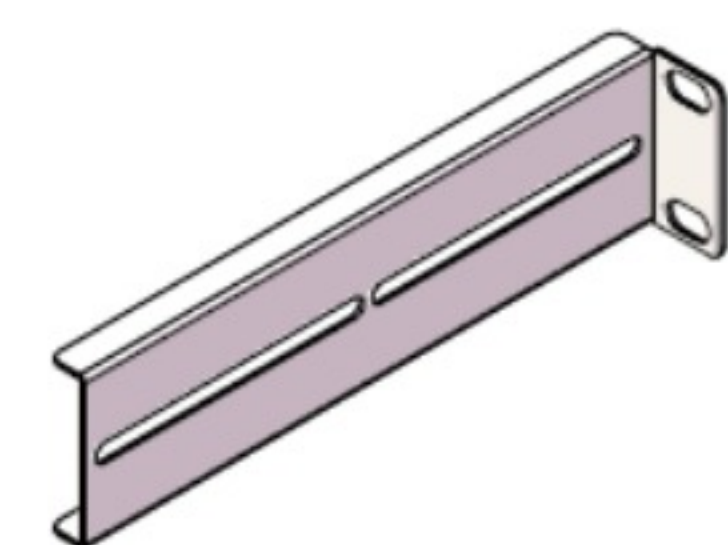

▲ AP-SAUL26掛耳

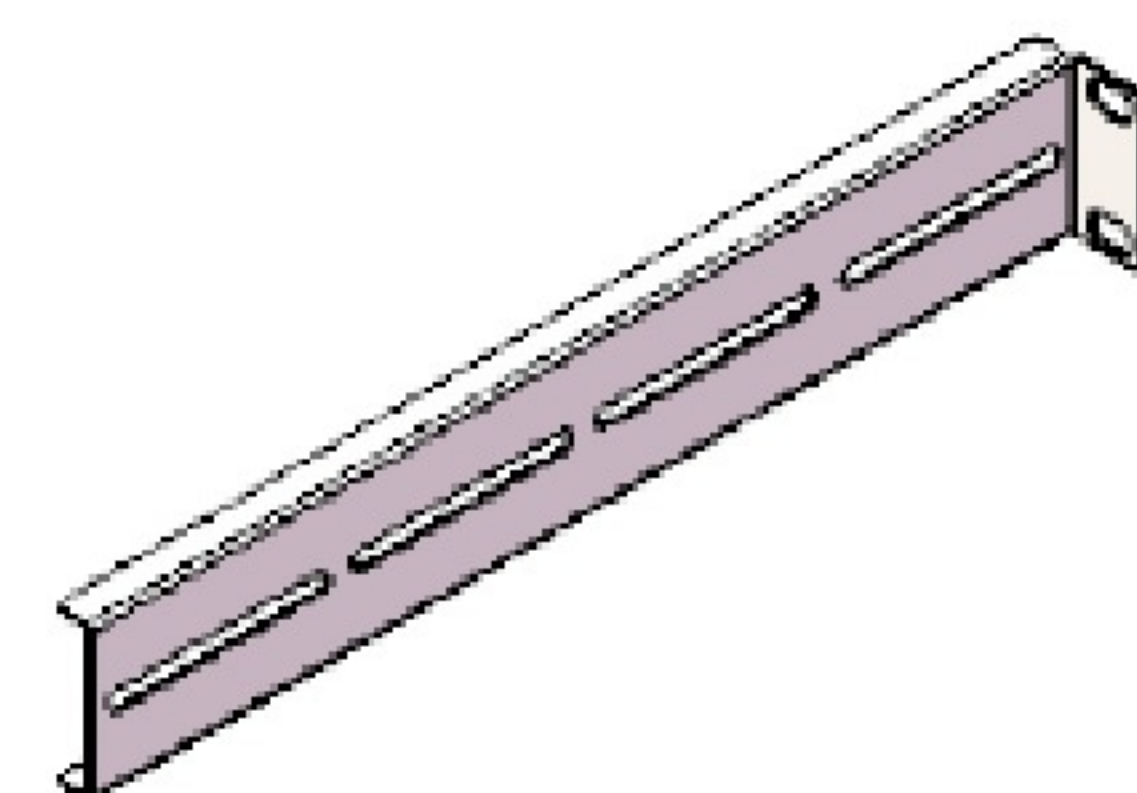

▲ AP-SAUL28/20掛耳

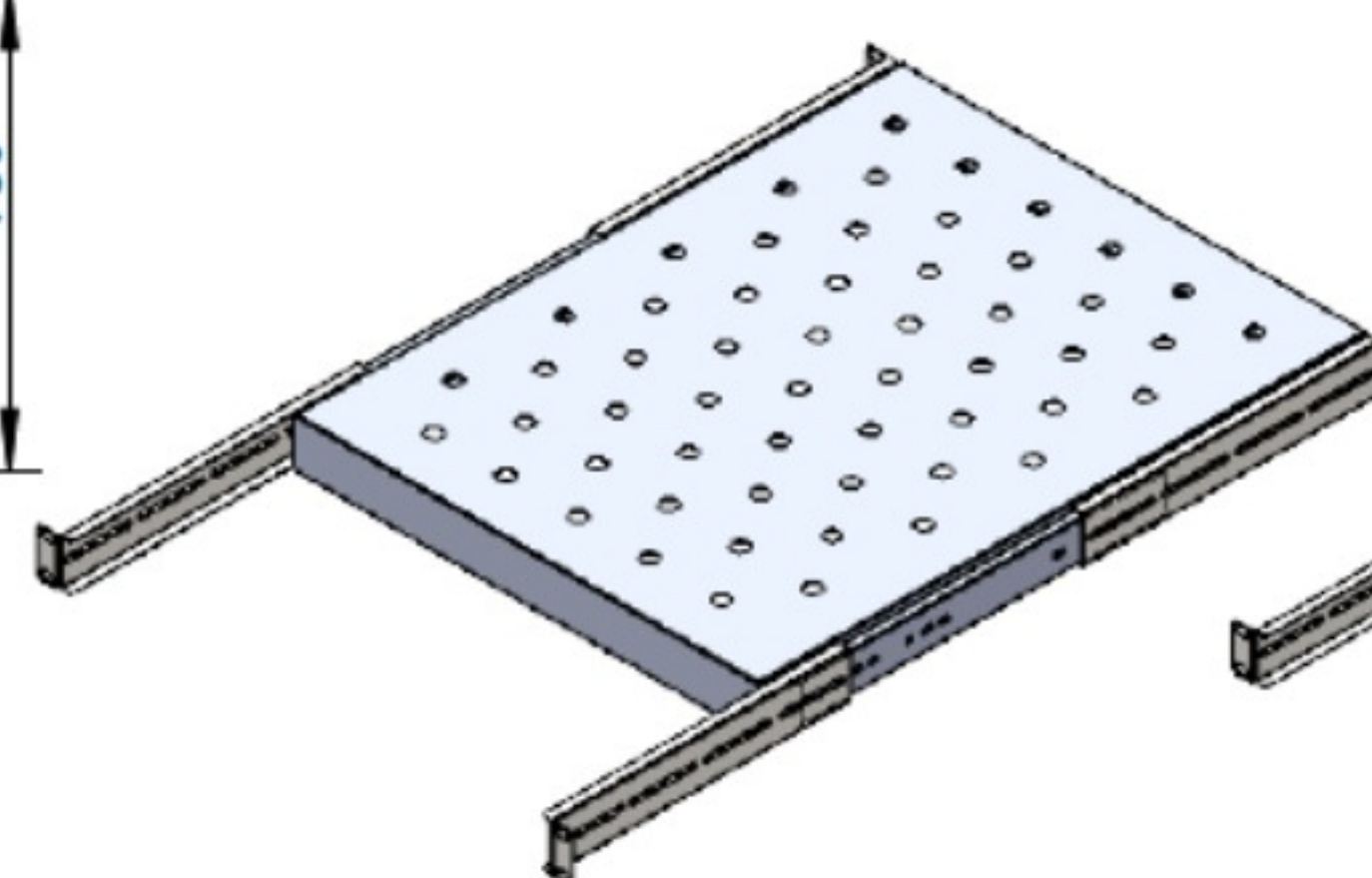

▲ AP-SAUL28

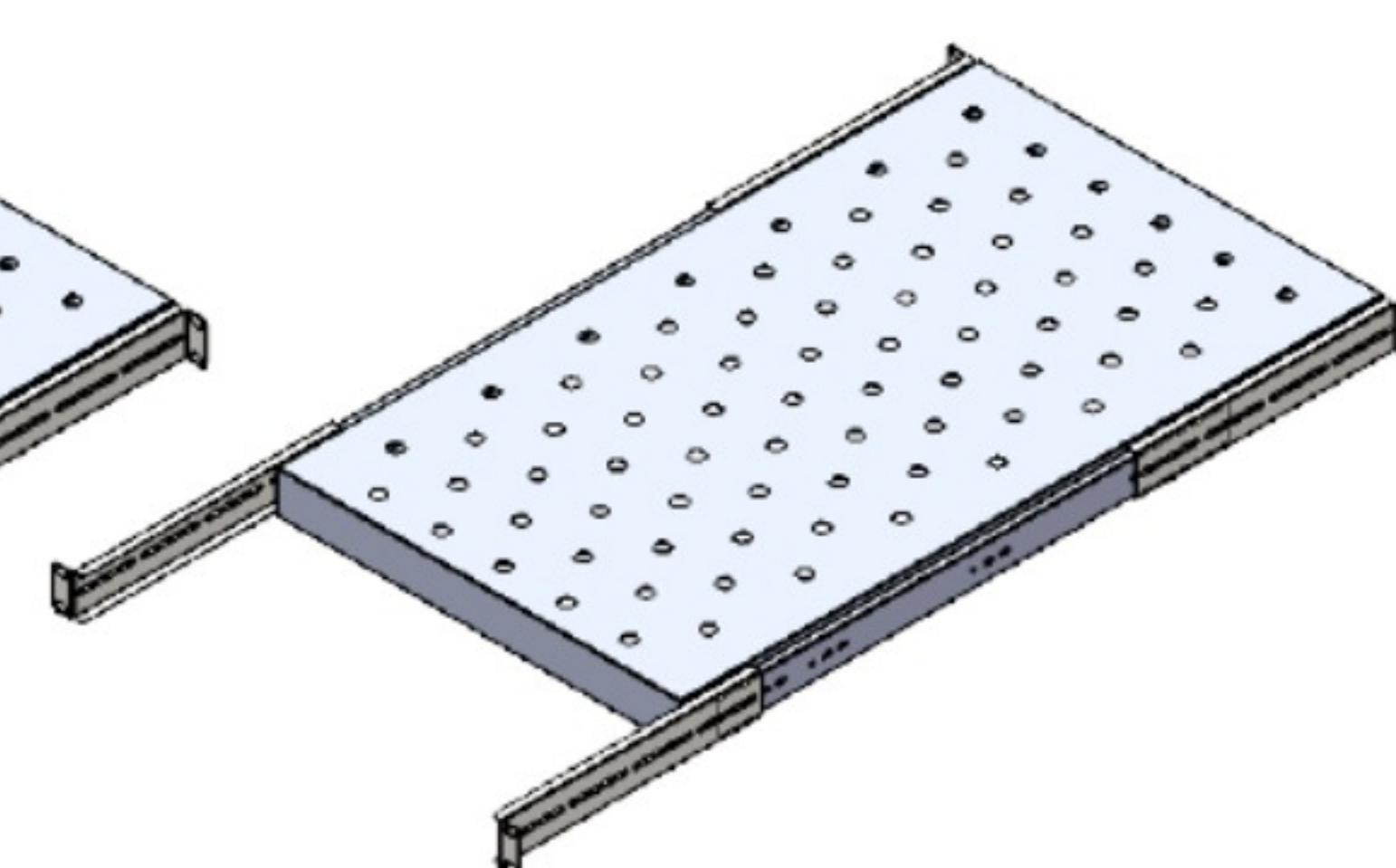

▲ AP-SAUL20

Model No.	Specification	Dimension(mm)				Use
		Width	Depth1	Depth2	Height	
AP-SAUL26	60 Sliding Shelf	483	350	550	45	19" Standard, extendable from 350mm-550mm
AP-SAUL28	80 Sliding Shelf	483	550	730	45	550mm-730mm
AP-SAUL20	100 Sliding Shelf	483	730	930	45	730mm-910mm

© The product specifications, dimensions, pictures and information mentioned in this catalog are for reference only, and the content may be updated at any time without prior notice.
 © The various data mentioned in this catalog may be different or have errors due to changes in the objective environment and other factors.

Network Cabinet Fan Unit

Material: SPCC cold rolled steel

Surface finish: Degreasing, phosphoric, powder coated

Thickness: Power Cord Box:1.2mm/Fan Tray:0.8mm

Cooling Fan: Low-noise, long lifespan

Air flowing: 50-110CBM/H

Color: AP-FA0000G AP-FA0000K



▲ AP-FA804

Model No.	Specification	Dimension(mm)			Use
		Width	Depth	Height	
AP-FA602	Fan Unit for 600mm cabinet 2 fans	298	130	44	For ANP 600mm depth Cabinet
AP-FA804	Fan Unit for 800/1000mm cabinet 4 fans	298	262	44	For ANP 800/1000mm depth Cabinet

Wall Mount Cabinet Fan Unit

Cooling Fan: Low-noise, long lifespan

Air flowing: 50-110CBM/H



Model No.	Specification	Dimension(mm)	
		Width	Depth
AP-FA402	120mm*120mm Fan Unit	120	120

1U Universal Fan Unit

Material: SPCC cold rolled steel t1.2

Surface finish: Degreasing, phosphoric, powder coated

Cooling Fan: Low-noise, long lifespan

Air flowing: 50-110CBM/H

Color: AP-FM402G

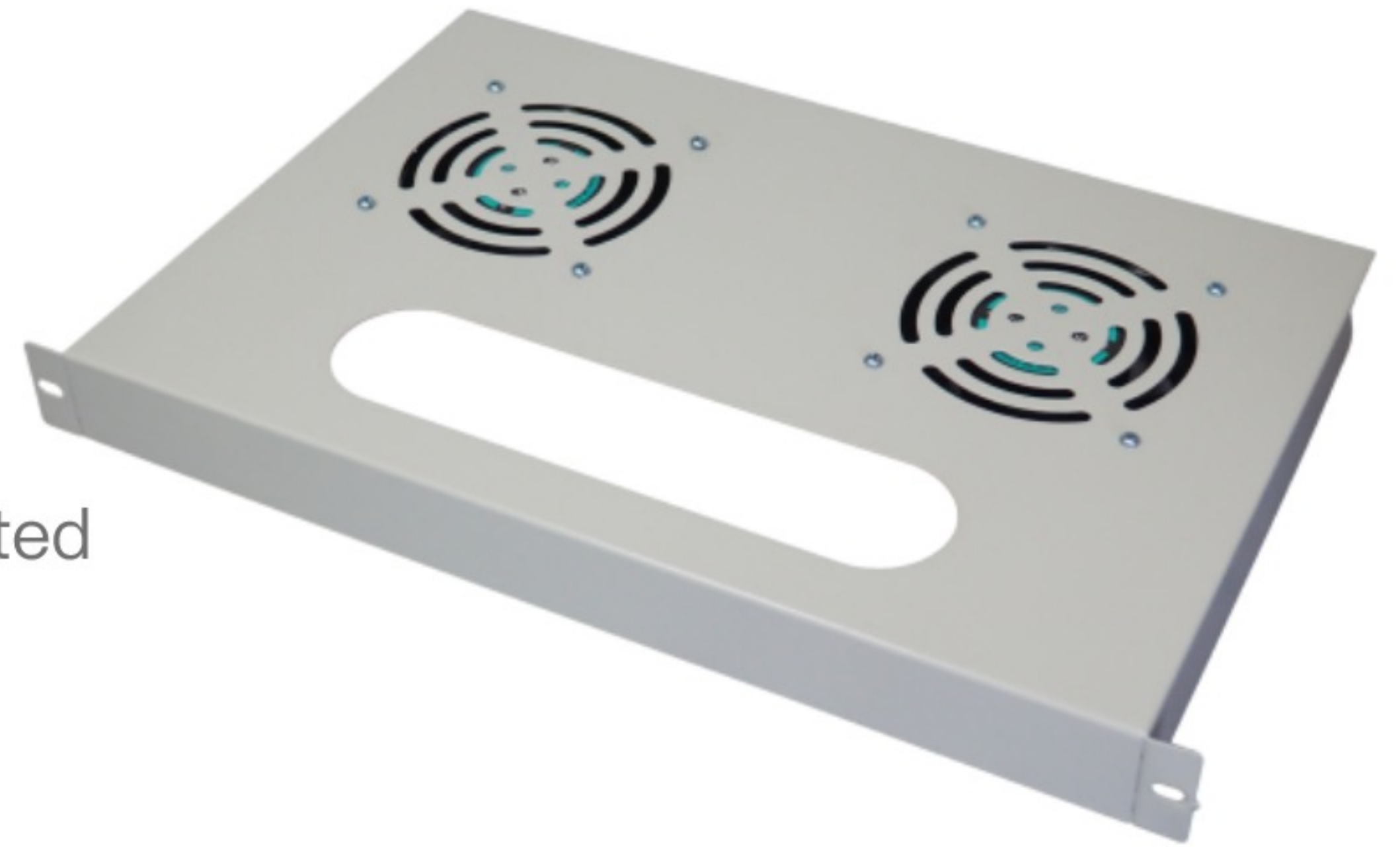

Model No.	Specification	Dimension(mm)			Use
		Width	Depth	Height	
AP-FM402	1U Universal 2 Fan Unit	482	300	45	19" Standard

3U Universal Fan Unit

Material: SPCC cold rolled steel t1.2

Surface finish: Degreasing, phosphoric, powder coated

Cooling Fan: Low-noise, long lifespan

Air flowing: 50-110CBM/H

Color: AP-FMH00G AP-FMH00K



▲ AP-FMH03

Model No.	Specification	Dimension(mm)		Use
		Width	Depth	
AP-FMH02	3U Universal 2 Fan Unit	482	88	19" Standard
AP-FMH03	3U Universal 3 Fan Unit	482	88	19" Standard

Cable Management with Cap

Material: SPCC cold rolled steel

Surface finish: Degreasing, phosphoric, powder coated

Color: AP-WMHC-□UG AP-WMHC-□UK



▲ AP-WMHC-1UK

Model No.	Specification	Dimension(mm)			Use
		Width	Depth	Height	
AP-WMHC-1U	1U cable management with cap	482	70	45	19" Standard
AP-WMHC-2U	2U cable management with cap	482	70	88	19" Standard

Cable Management with Rings

Material: SPCC cold rolled steel

Surface finish: Degreasing, phosphoric, powder coated

Color: AP-WMHD-□UK



▲ AP-WMHD-1UK

Model No.	Specification	Dimension(mm)			Use
		Width	Depth	Height	
AP-WMHD-1U	1U cable management with D rings	482	70	45	19" Standard
AP-WMHD-2U	2U cable management with D rings	482	70	88	19" Standard

C Ring Cable Hook

Material: SPCC cold rolled steel, t1.2

Surface finish: Degreasing, phosphoric, powder coated

Color: ● AP-WMHV-00K

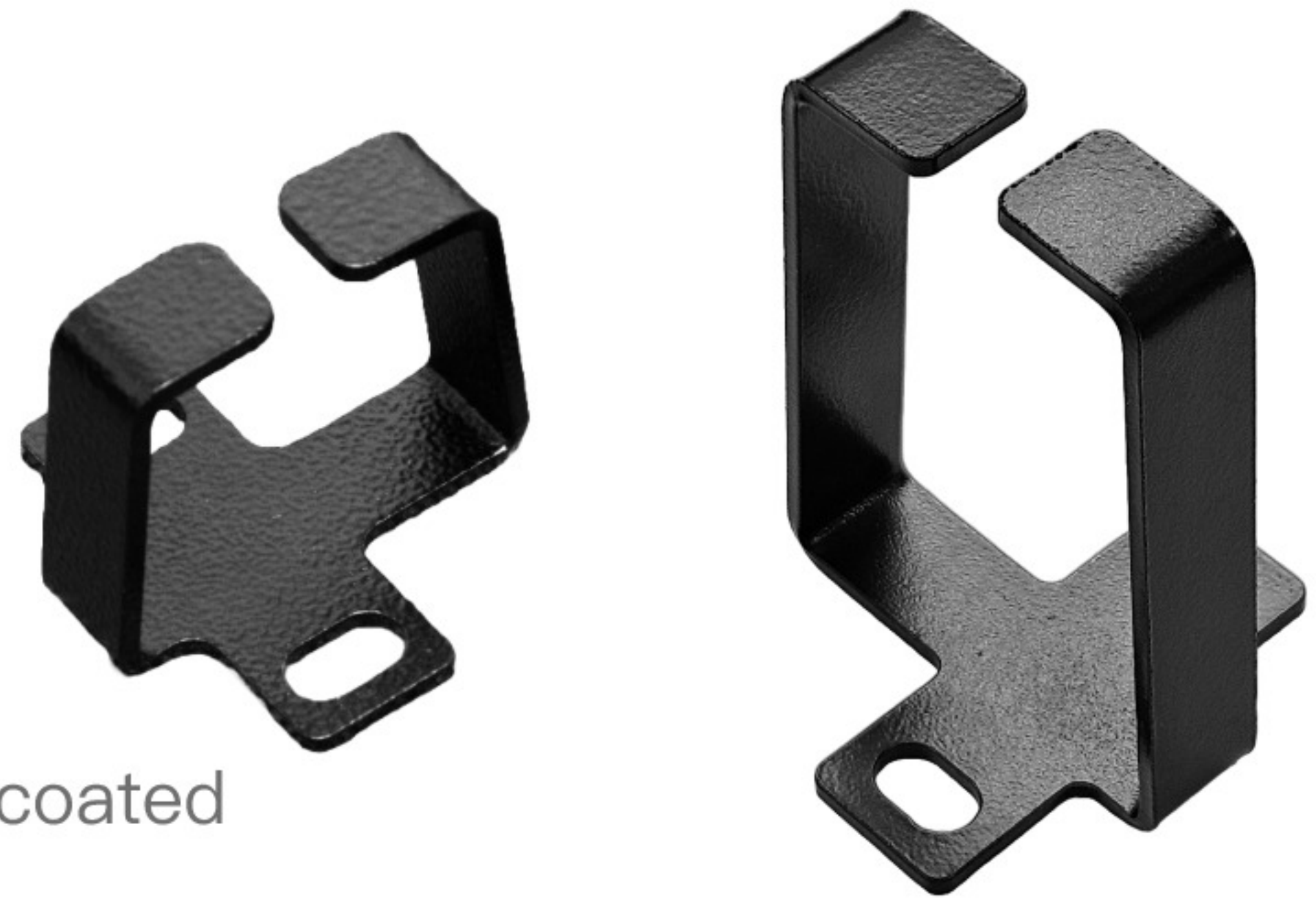

▲ AP-WMHV-10K

▲ AP-WMHV-25K

Model No.	Specification	Dimension(mm)
		Height
AP-WMHV-10K	for 6-10 network Cables	35
AP-WMHV-25K	for 20-25 network Cables	60

D Ring Cable Hook

Material: Steel

Surface finish: Zine plated



▲ AP-WMHV-D

Model No.	Specification	Dimension(mm)
		Height
AP-WMHV-D	for 25-30 network Cables	70

Monitor Mounting Bracket Angle Adjustable

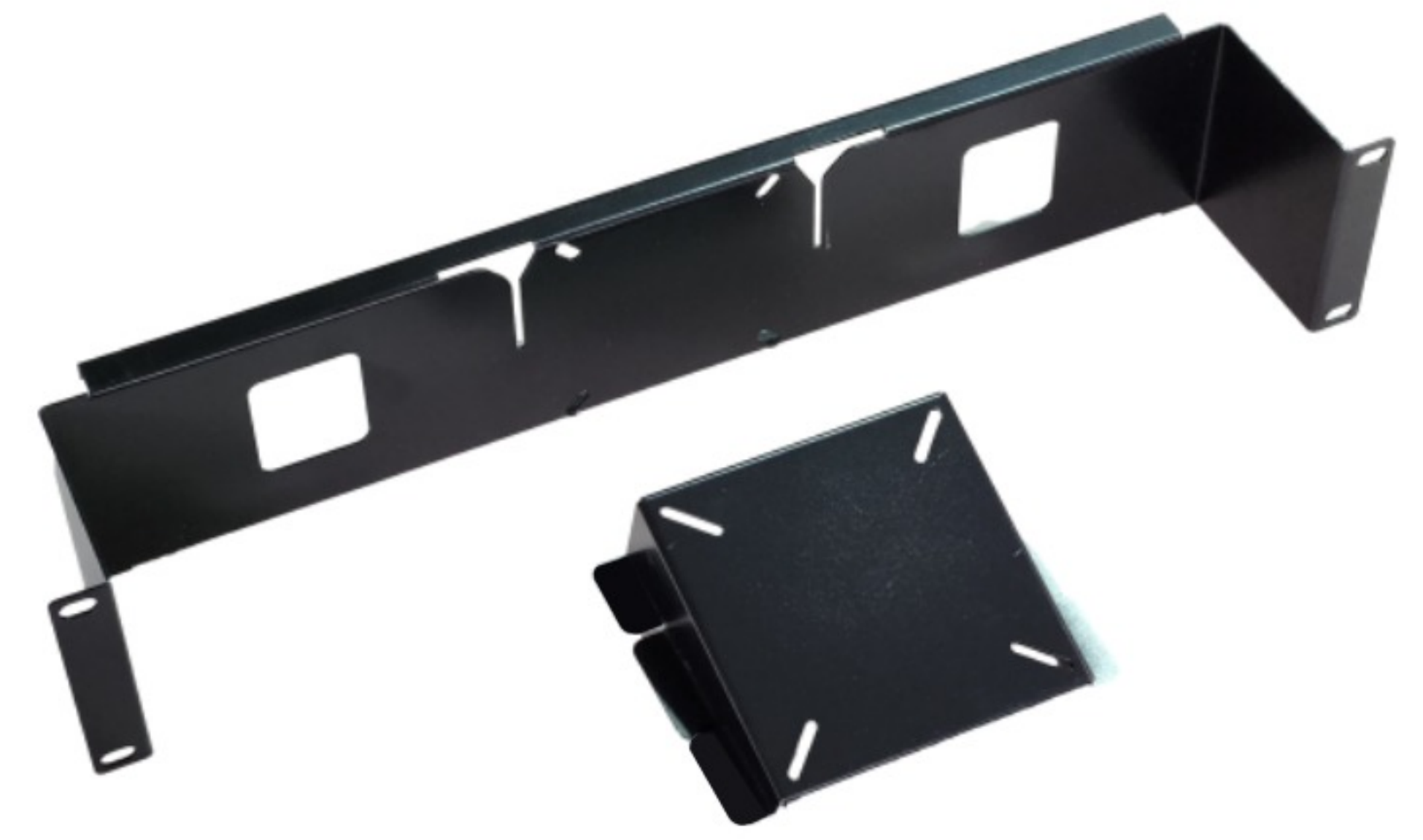

Material: SPCC cold rolled steel t1.5

Surface finish: Degreasing, phosphoric, powder coated

Parameter: Maximum monitor width: 430mm

2 mounting angles available

Color: AP-AYMBKT-1G AP-AYMBKT-1K

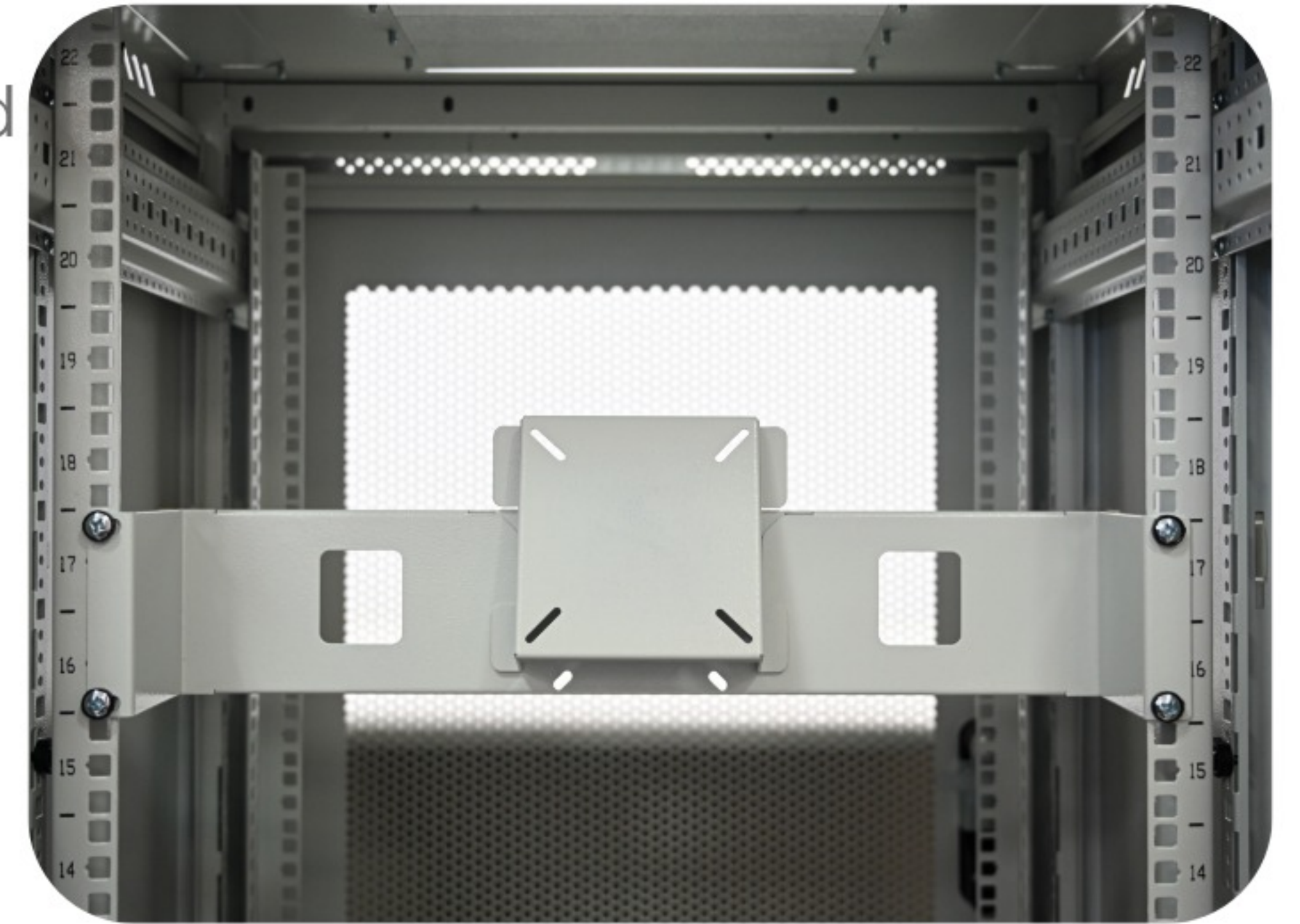

Model No.	Specification	Dimension(mm)			Use
		Width	Depth	Height	
AP-AYMBKT-1	Monitor Mounting Bracket Angle Adjustable	482	105	88	19" Standard

Monitor Mounting Bracket Flat

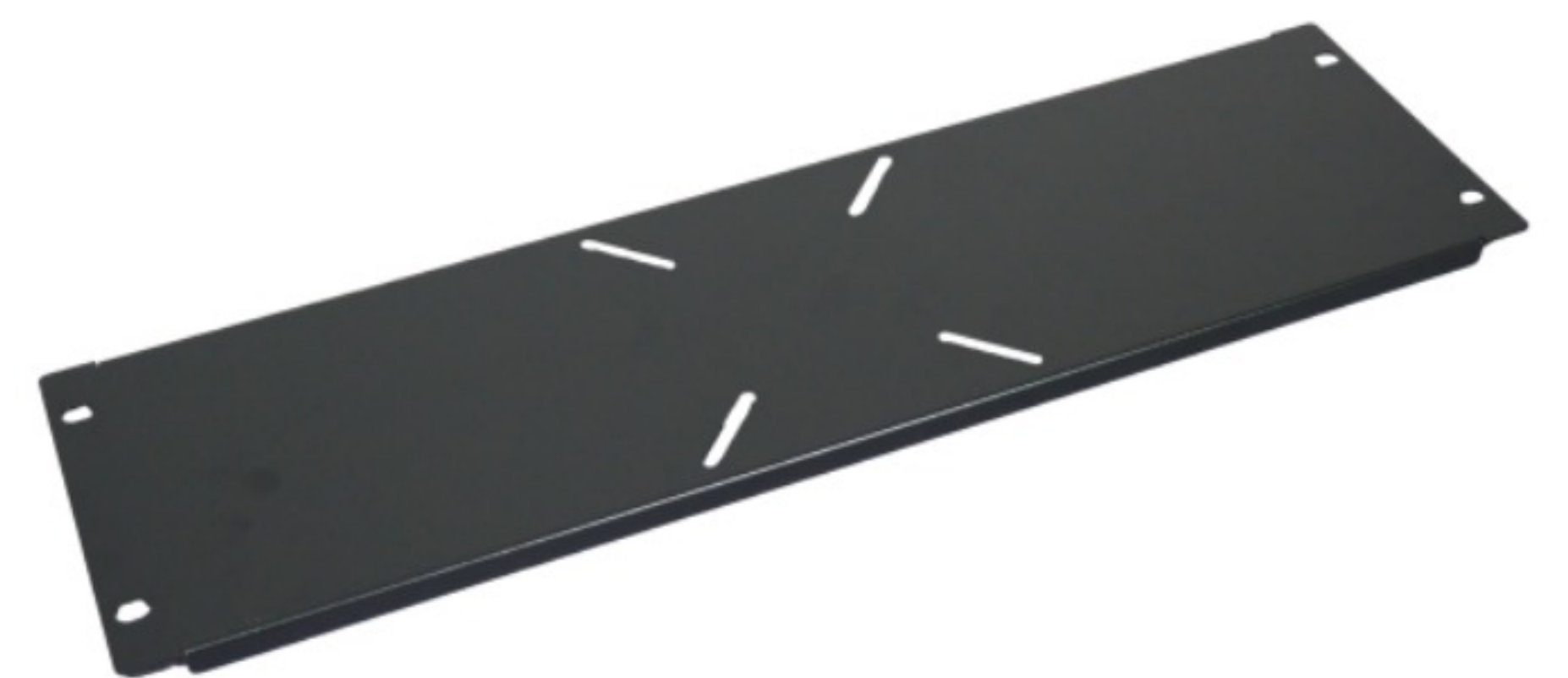

Material: SPCC cold rolled steel t1.5

Surface finish: Degreasing, phosphoric, powder coated

Parameter: Maximum monitor width: 530mm

fixed mounting angles

Color: AP-AYMBKT-2K

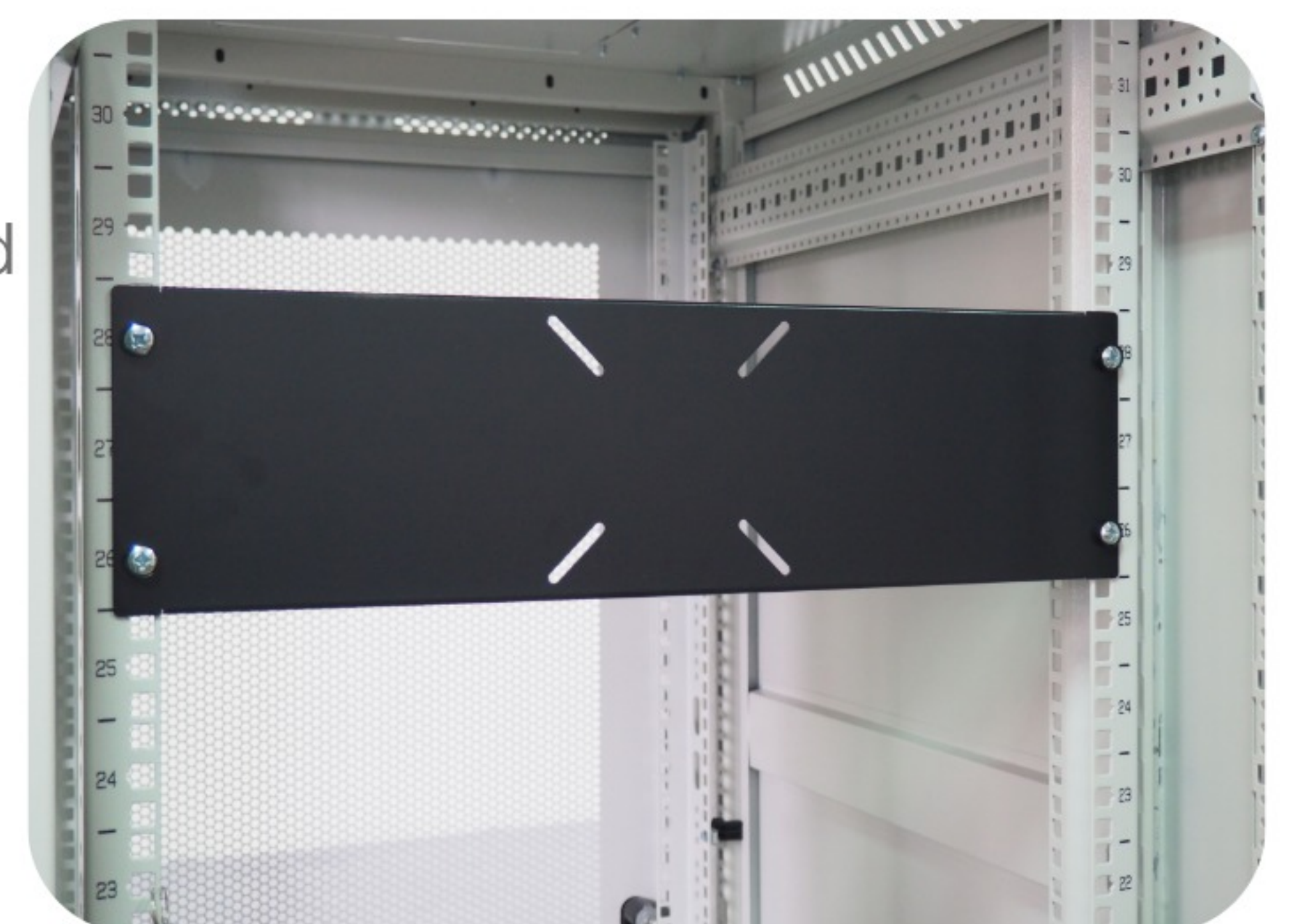

Model No.	Specification	Dimension(mm)		Use
		Width	Height	
AP-AYMBKT-2	monitor mounting bracket flat type	482	133	19" Standard

Monitor Arm

Material: SPCC cold rolled steel ;
Aluminum alloy ; ABS

VESA Pattern: 75*75 / 100*100mm

Loading Capacity: 2~9kgs



▲ AP-AYMBKT-3

Model No.	Specification	Use
AP-AYMBKT-3	Monitor Arm	Need to use with Network Cabinet Flat Cover

Network Cabinet Flat Cover

Material: SPCC cold rolled steel t1.5

Surface finish: Degreasing, phosphoric,
Powder coated

Loading Capacity: 20kgs



Color: ○ AP-CATC□□G ● AP-CATC□□K

▲ AP-CATC66G

Model No.	Specification	Dimension(mm)			Use
		Width	Depth	Height	
AP-CATC66	Network Cabinet Flat Cover	590	480	25	For ANP 600mm depth Cabinet
AP-CATC68	Network Cabinet Flat Cover	590	680	25	For ANP 800mm depth Cabinet
AP-CATC60	Network Cabinet Flat Cover	590	880	25	For ANP 1000mm depth Cabinet

1U Brush Strip

Material: SPCC cold rolled steel t1.5

Surface finish: Degreasing, phosphoric, powder coated

Brush Area: 390 × 30 (mm)

Color: ● AP-ATBRO-1UK



Model No.	Specification	Dimension(mm)		Use
		Width	Height	
AP-ATBRP-1UK	1U Cable Entry Perforated Panel with Brush	482	44	19" Standard

Base Brush Strip

Material: SPCC cold rolled steel t1.5

Surface finish: Degreasing, phosphoric, powder coated

Brush Area: 240 × 50 (mm)

Color: ● AP-ATBRP-0UK

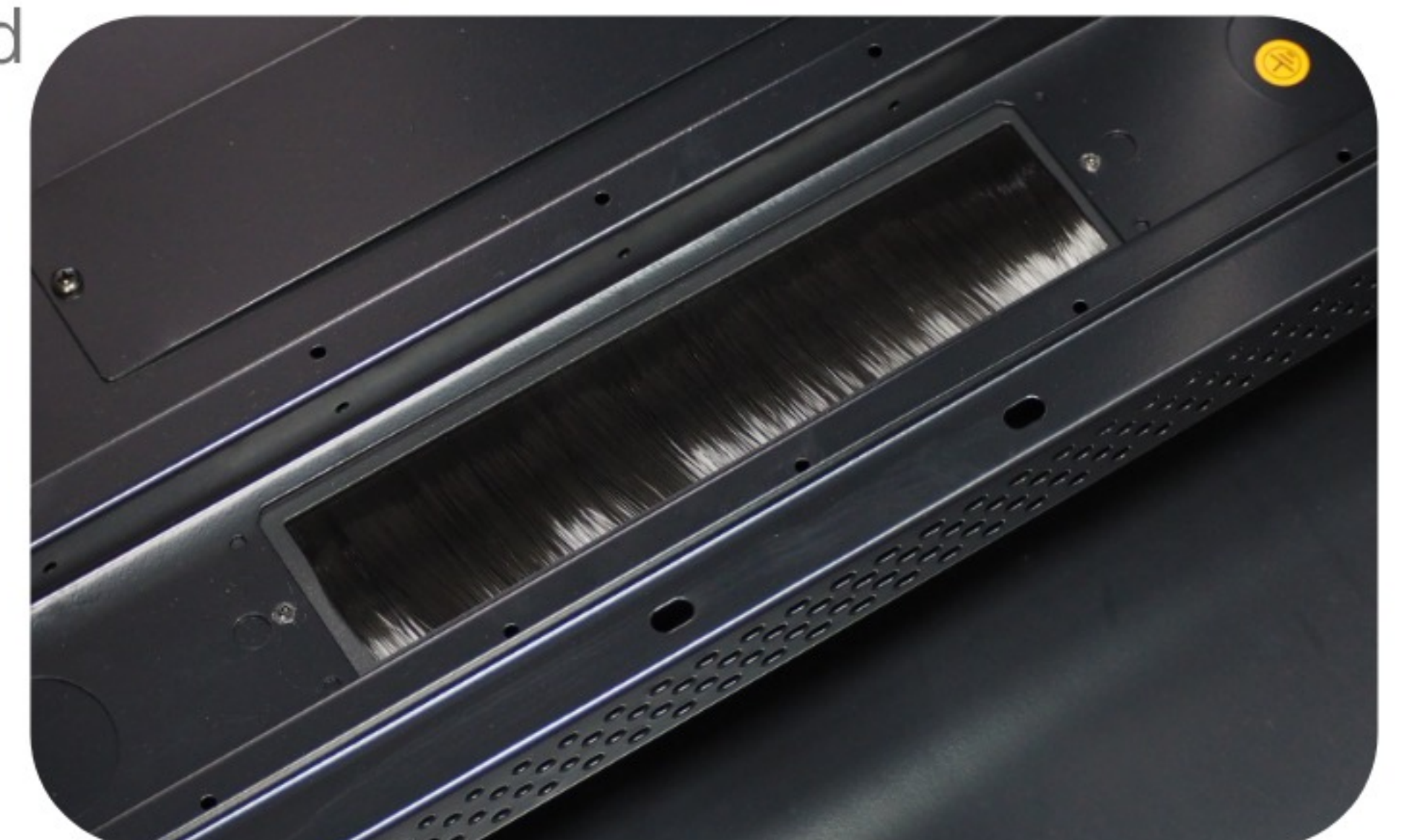

Model No.	Specification	Dimension(mm)		Use
		Width	Height	
AP-ATBRP-0UK	Bottom Brush Strip	277	65	Applicable to 【ANP】 floor mount cabinets

L Rail



Material: SPCC cold rolled steel t1.5

Surface finish: Degreasing, phosphoric, powder coated

Color: AP-AYLR000G AP-AYLR000K



Model No.	Specification	Dimension(mm)			Use
		Width	Depth	Height	
AP-AYLR600	60 L Rail, 2pcs per set	350	60	38	19" Standard
AP-AYLR800	80 L Rail, 2pcs per set	550	60	38	19" Standard
AP-AYLR000	100 L Rail, 2pcs per set	730	60	38	19" Standard

Blank Panel



Material: SPCC cold rolled steel t1.0

Surface finish: Degreasing, phosphoric, powder coated

Color: AP-AYBP-0UG AP-AYBP-0UK

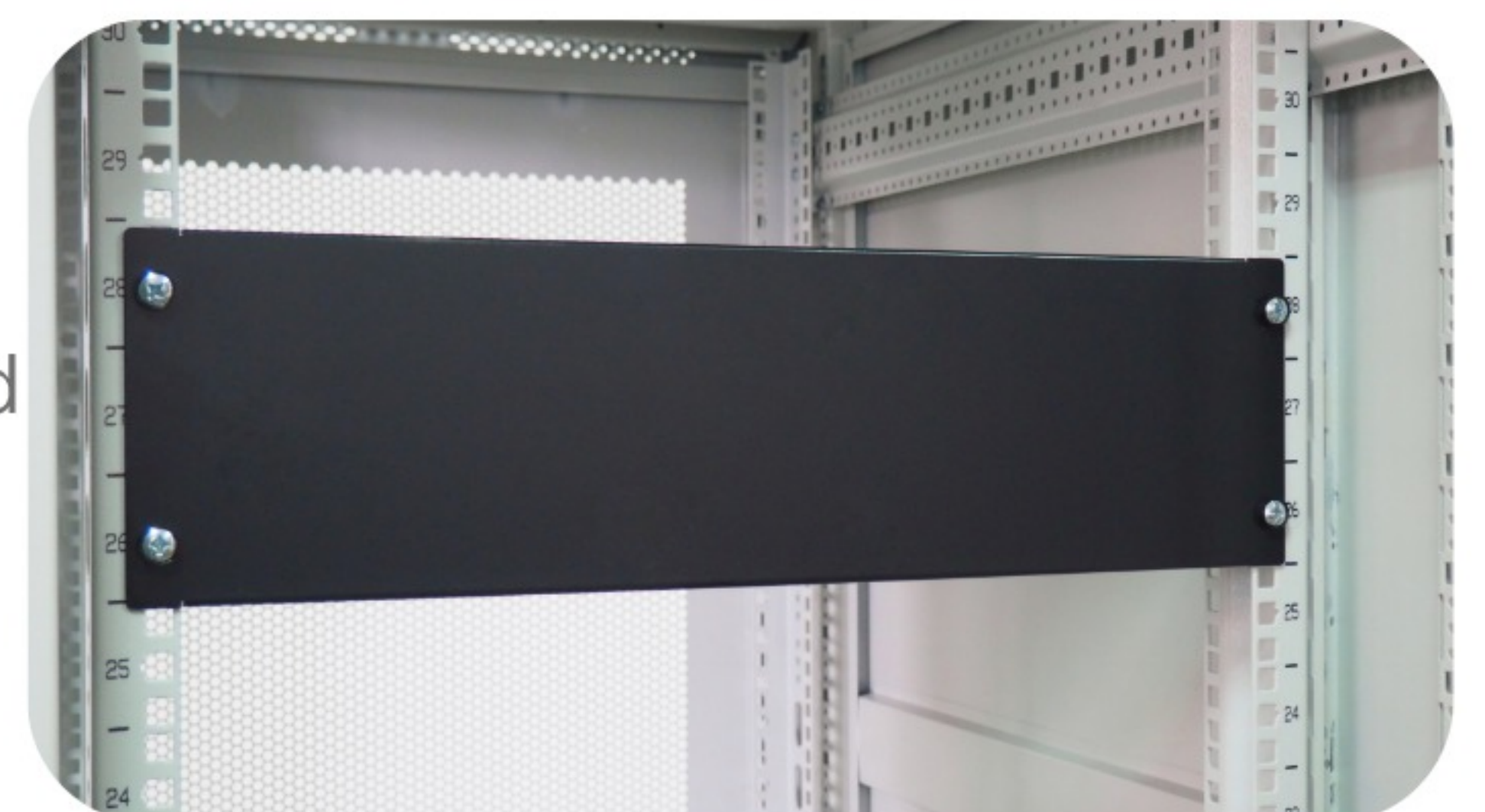

Model No.	Specification	Dimension(mm)		Use
		Width	Height	
AP-AYBP-1U	1U Blank Panel	482	45	19" Standard
AP-AYBP-2U	2U Blank Panel	482	88	19" Standard
AP-AYBP-4U	4U Blank Panel	482	178	19" Standard

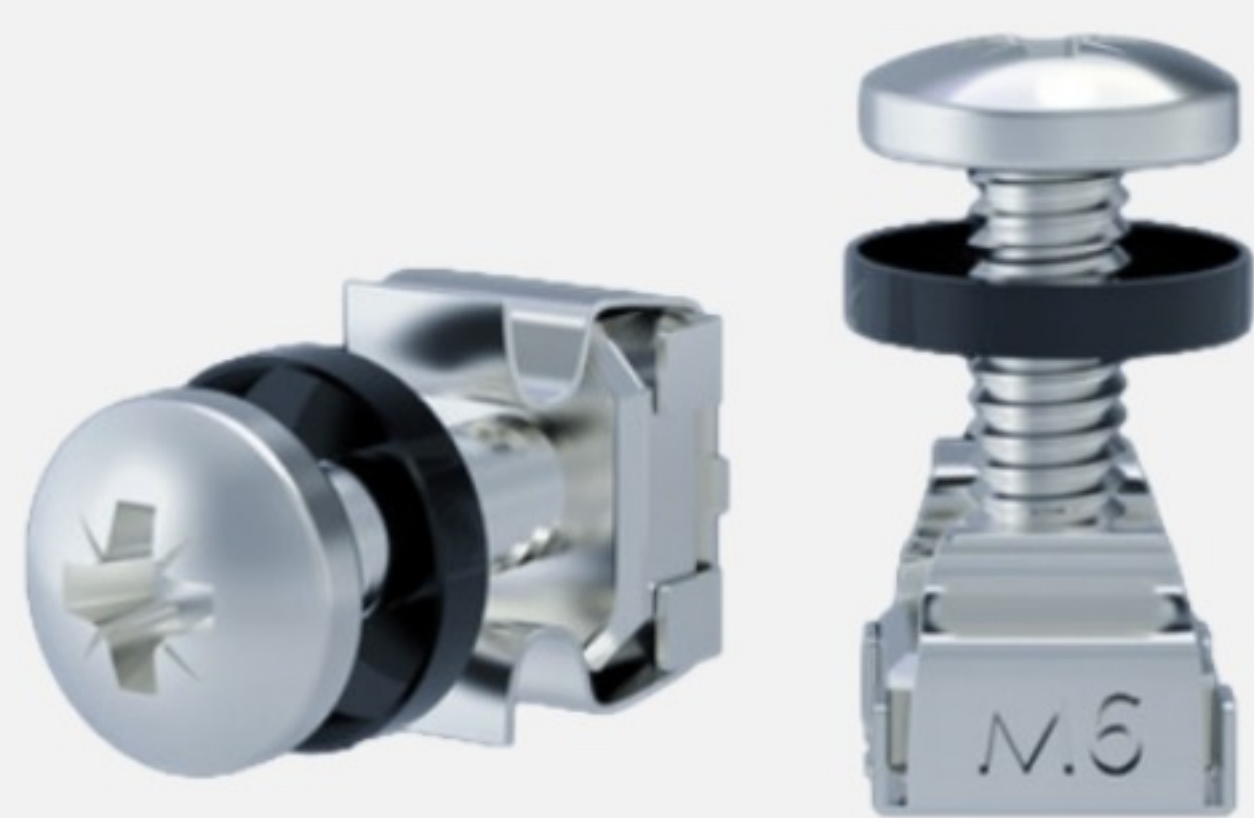

Screw & Nut with Cushion

Screws: M6*12; Nut: M6; Washer: $\Phi 6$;
Surface Finish: Plate nickel.

AP-AAM6100 | M6 Gage, 10pcs per bag

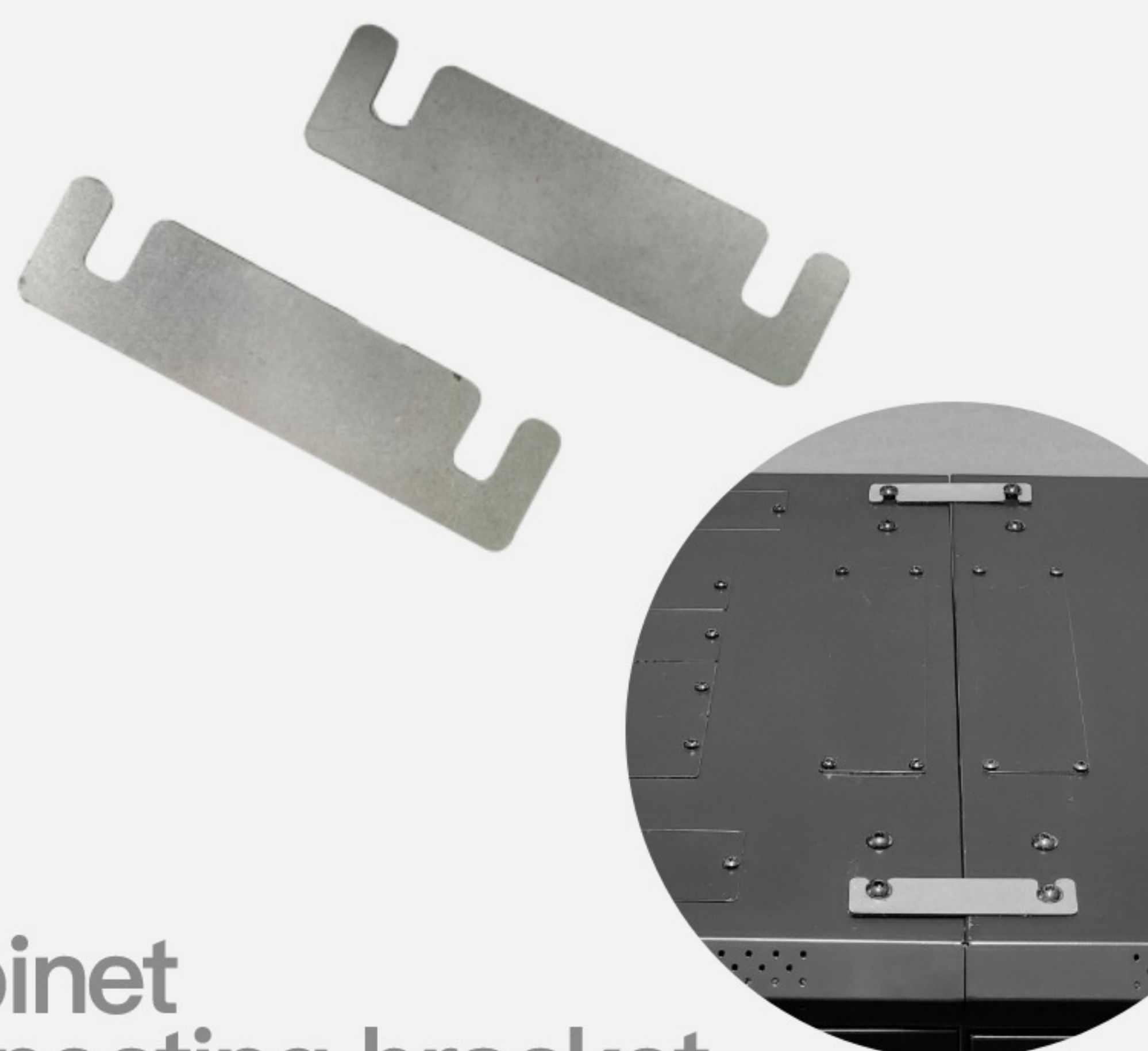

Cabinet connecting bracket

Special connection board for ANP cabinets
SUS304 stainless steel matte treatment

AP-CJBS | For **[ANP]** cabinets



Wall Mount Cabinet Castors

2" Heavy Duty Castor
360-degree optional rotation; with brakes
Material: galvanized, PVC

AP-WA-Castor | 2" Heavy Duty Castor

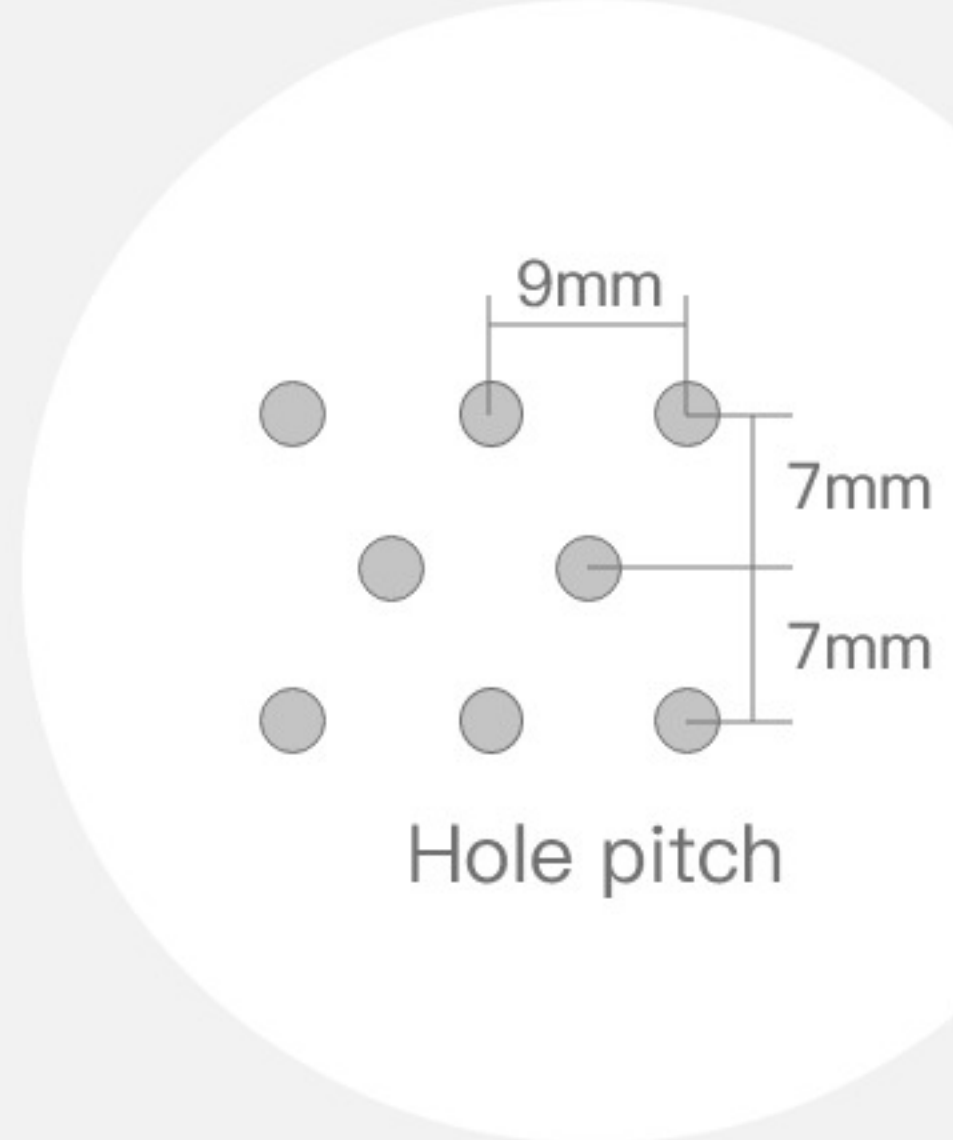

1U Universal Equipment Mounting Plate

Material: SPCC cold rolled steel t1.5
 Surface Finish: Degreasing, phosphoric, powder coated

AP-ATMP-1UK | 19" Standard

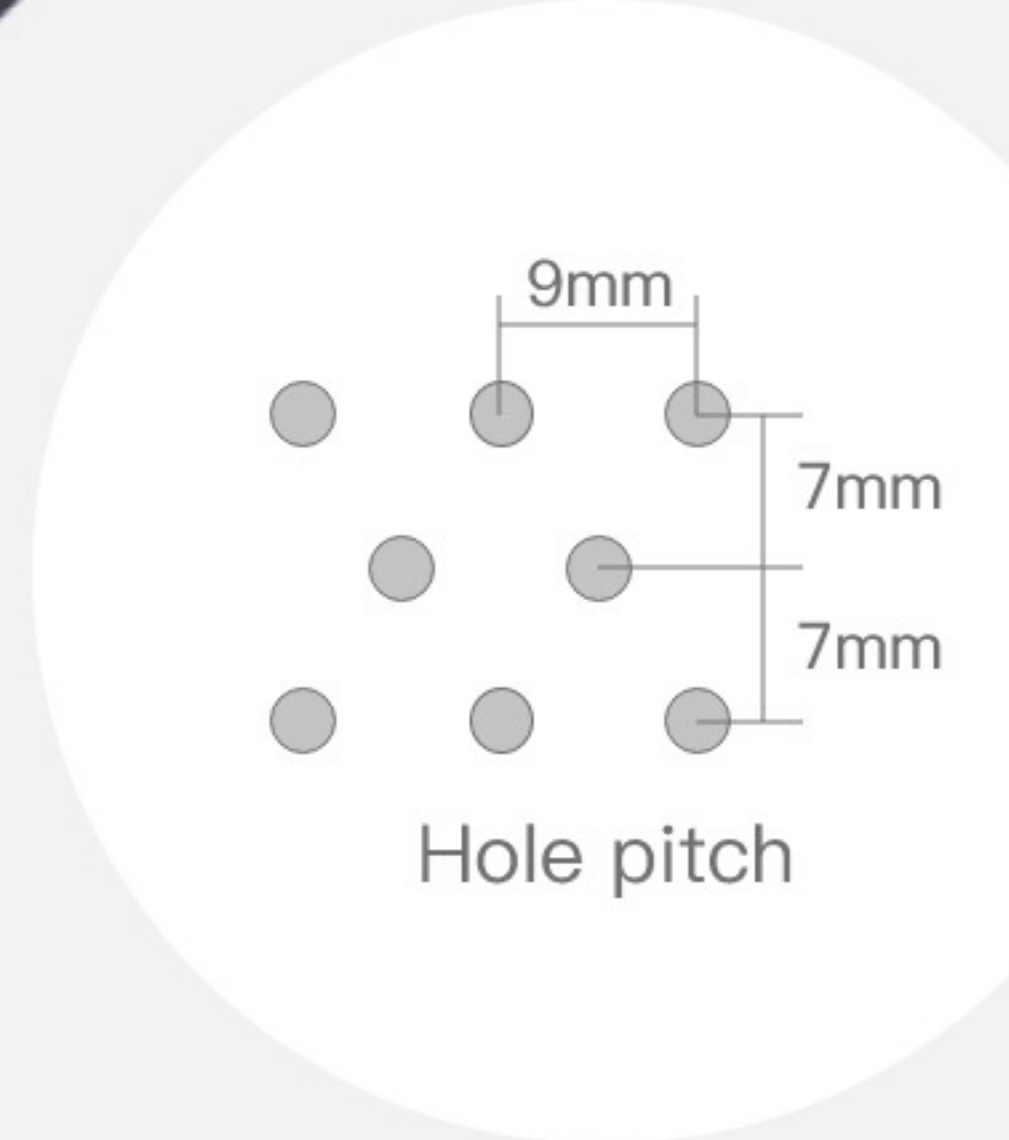
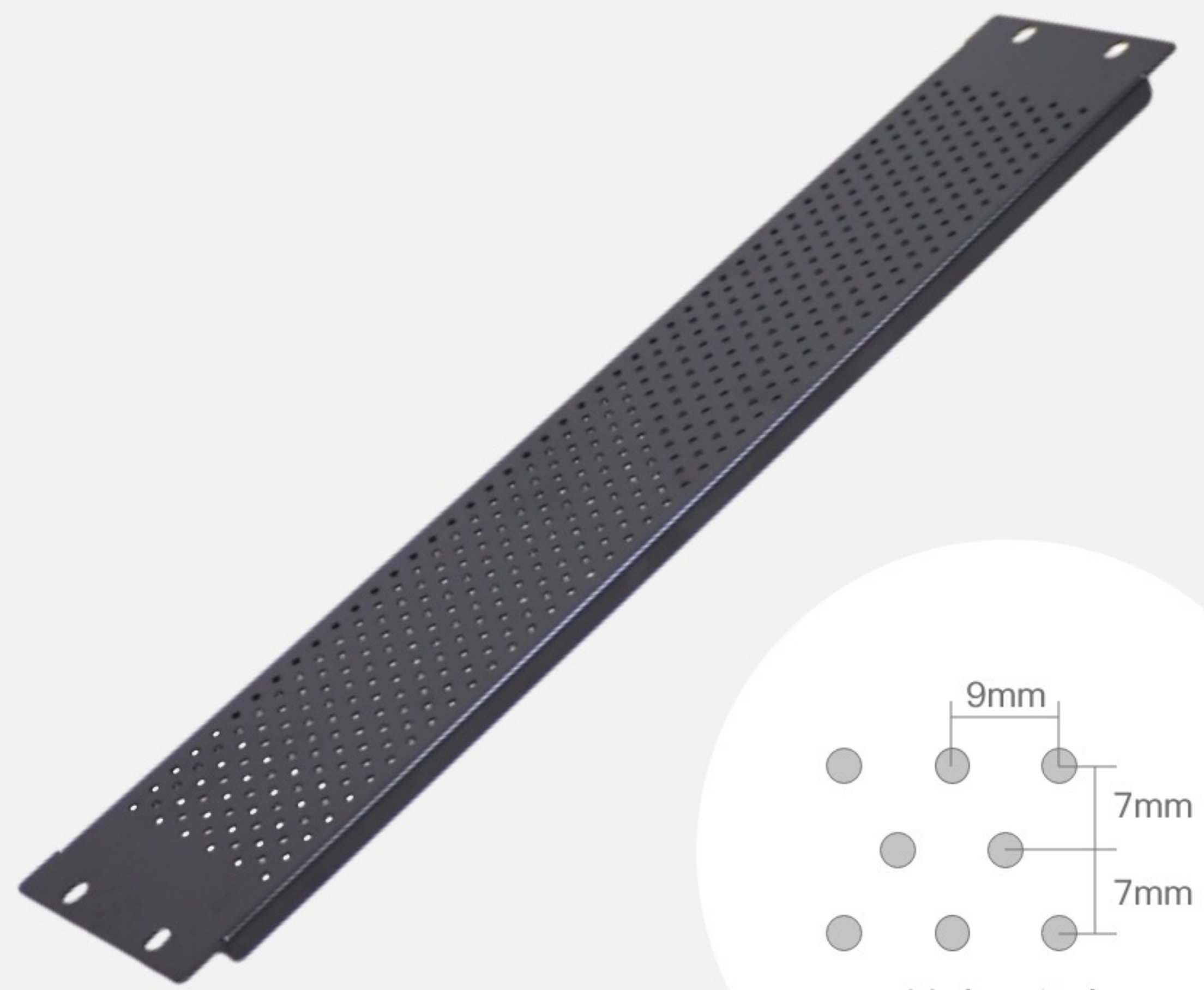

2U Universal Equipment Mounting Plate

Material: SPCC cold rolled steel t1.5
 Surface Finish: Degreasing, phosphoric, powder coated

AP-ATMP-2UK | 19" Standard



6 Outlet PDU

- Outlet: 6 UL type
- Max Output Power: 1650W
- Rated Voltage: 110V
- Surge Protector: Yes
- Max Current: 15A
- Main Switch: Yes with light

AP-PDU615ASPK | 19" Standard



8 Outlet PDU

- Outlet: 8 UL type
- Max Output Power: 1650W
- Rated Voltage: 110V
- Surge Protector: No
- Max Current: 15A
- Main Switch: Yes with light

AP-PDU815AK | 19" Standard

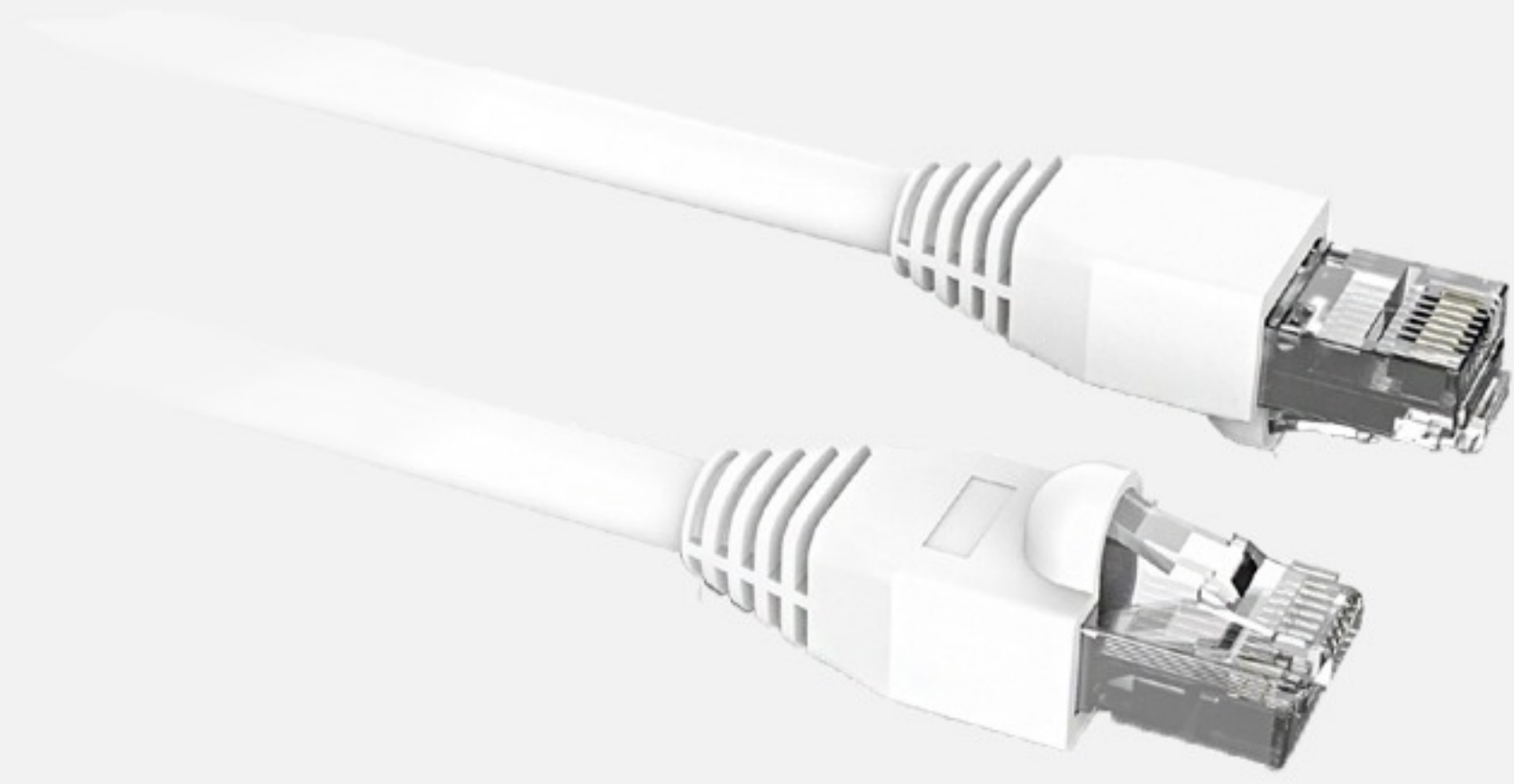

Patch Cord

CAT.6 Patch Cord high-speed network cables
10–30 meters RJ45 connectors on both sides
contain shrapnel protection sleeves

AP-1845C6 Patch Cord | CAT6 Patch Cord



Cat3 RJ12 Keystone Jack

Colour: Black
110 IDC Piercing Block
Compatible with 23 to 26 AWG solid wire

AP-1007C3K | Network Products



Cat6 RJ45 90° Keystone Jack

Color: blue
110 IDC Piercing Block
Compatible with 23 to 26 AWG solid wire

AP-1006C6U | Network Products

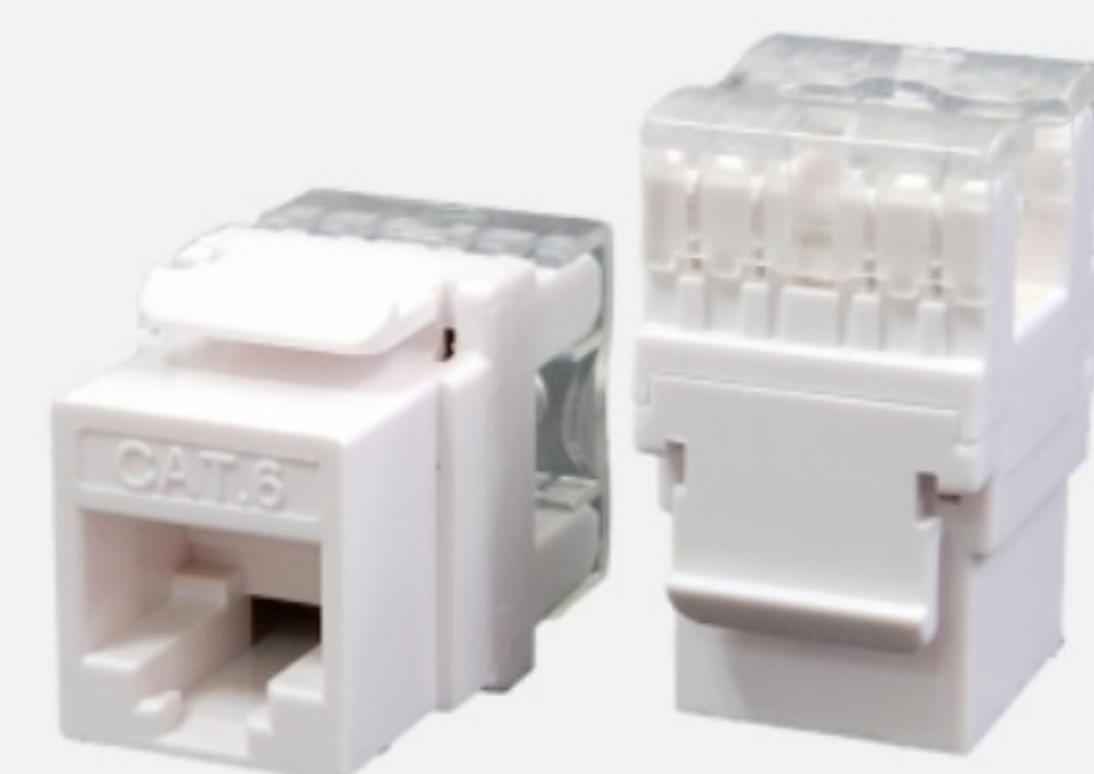

Cat6 RJ45 180° Keystone Jack

Color: White
110 IDC Piercing Block
Compatible with 23 to 26 AWG solid wire

AP-1005C6W | Network Products

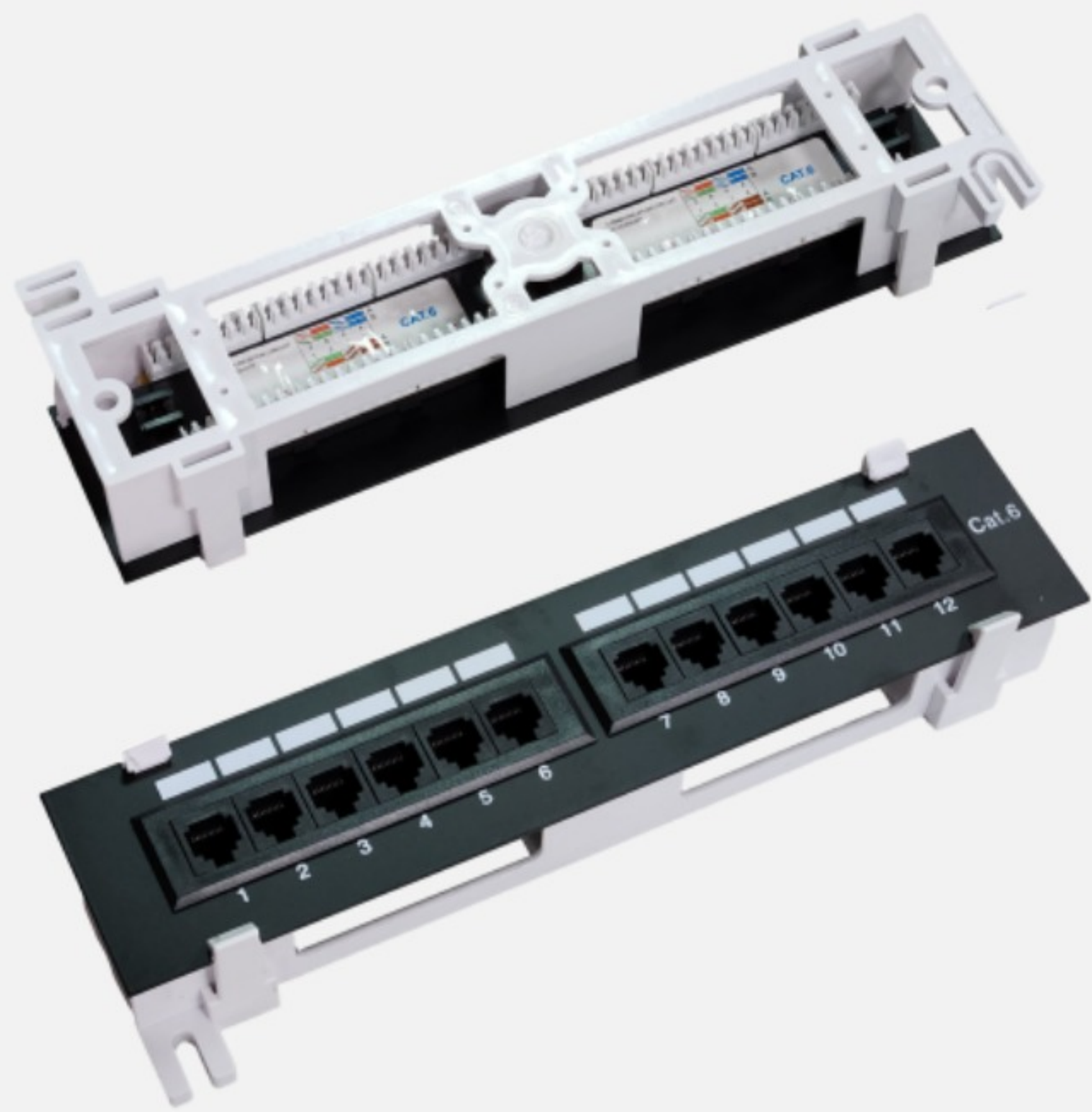

Cat6 12 Ports Patch Panel

Cat6 RJ45 12 Ports Patch Panel
Compatible with 23 to 26 AWG solid wire

AP-2804C6-12 | 19" Standard



24 Port Blank Patch Panel

RJ45 24-Port UTP
Unshielded Blank Keystone Patch Panel 1U
*Mind the gap when inserting
AP-1007C3K AP-1006C6U

AP-2804KBP-24 | 19"標準



Cat6 24 Ports Patch Panel

Cat6 RJ45 24 Ports Patch Panel
Compatible with 23 to 26 AWG solid wire

AP-2804C6-24 | 19" Standard

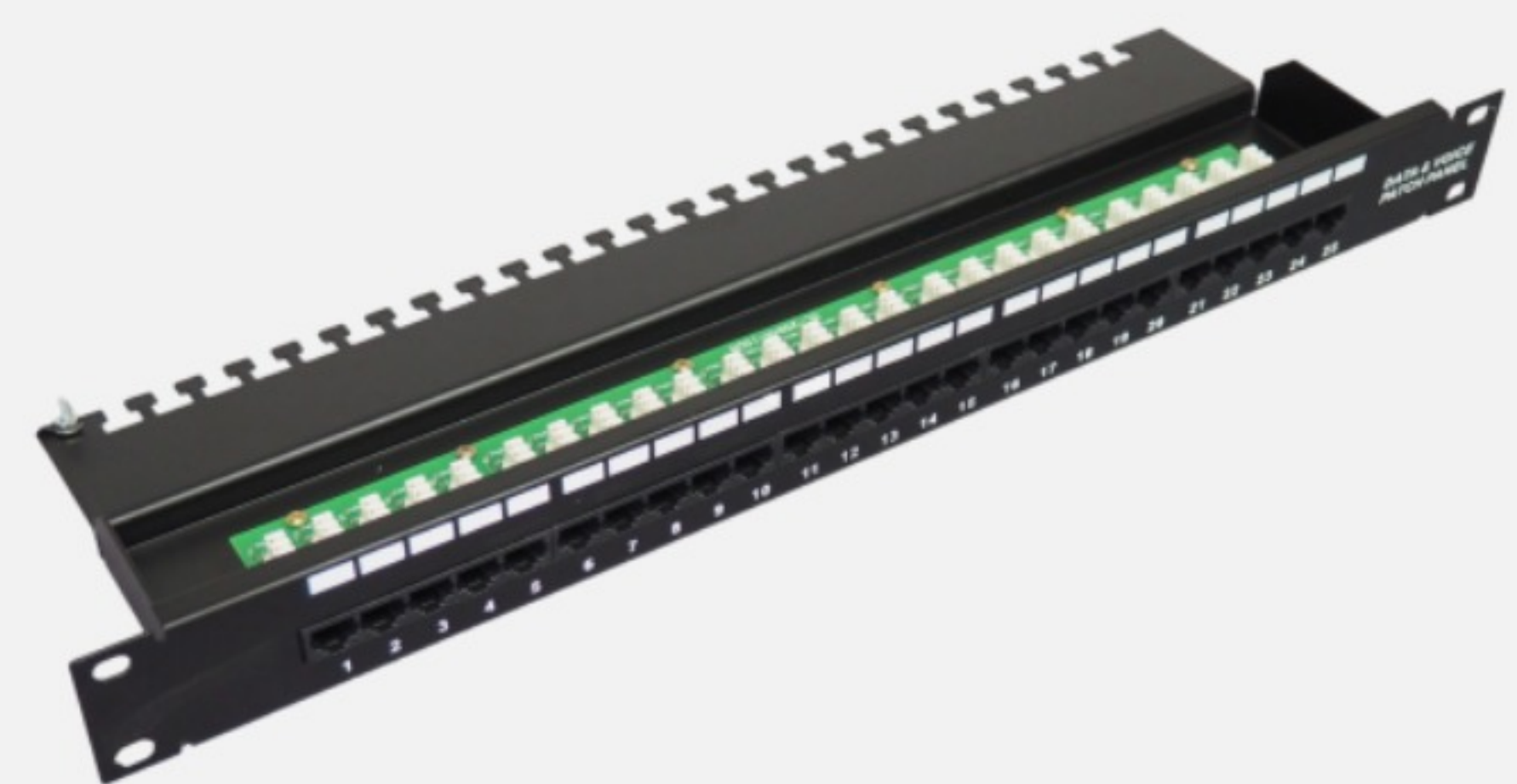

Cat6 25 Ports Patch Panel

Cat3 ISDN RJ11 Patch Panel
Designed with rear cable management rack
Compatible with 23 to 26 AWG solid wire
Female seat shared by RJ11 and RJ45

AP-2804C3-25 | 19" Standard



Cabinet Side Doors Lock

Specification: Universal Type
Surface Finish: Plate Chrome

AP-AY-C4035L | Round Lock



Spring Lock

Applicable to 【ANP】 all series cabinets

AP-AY-H200L | For 【ANP】 cabinets

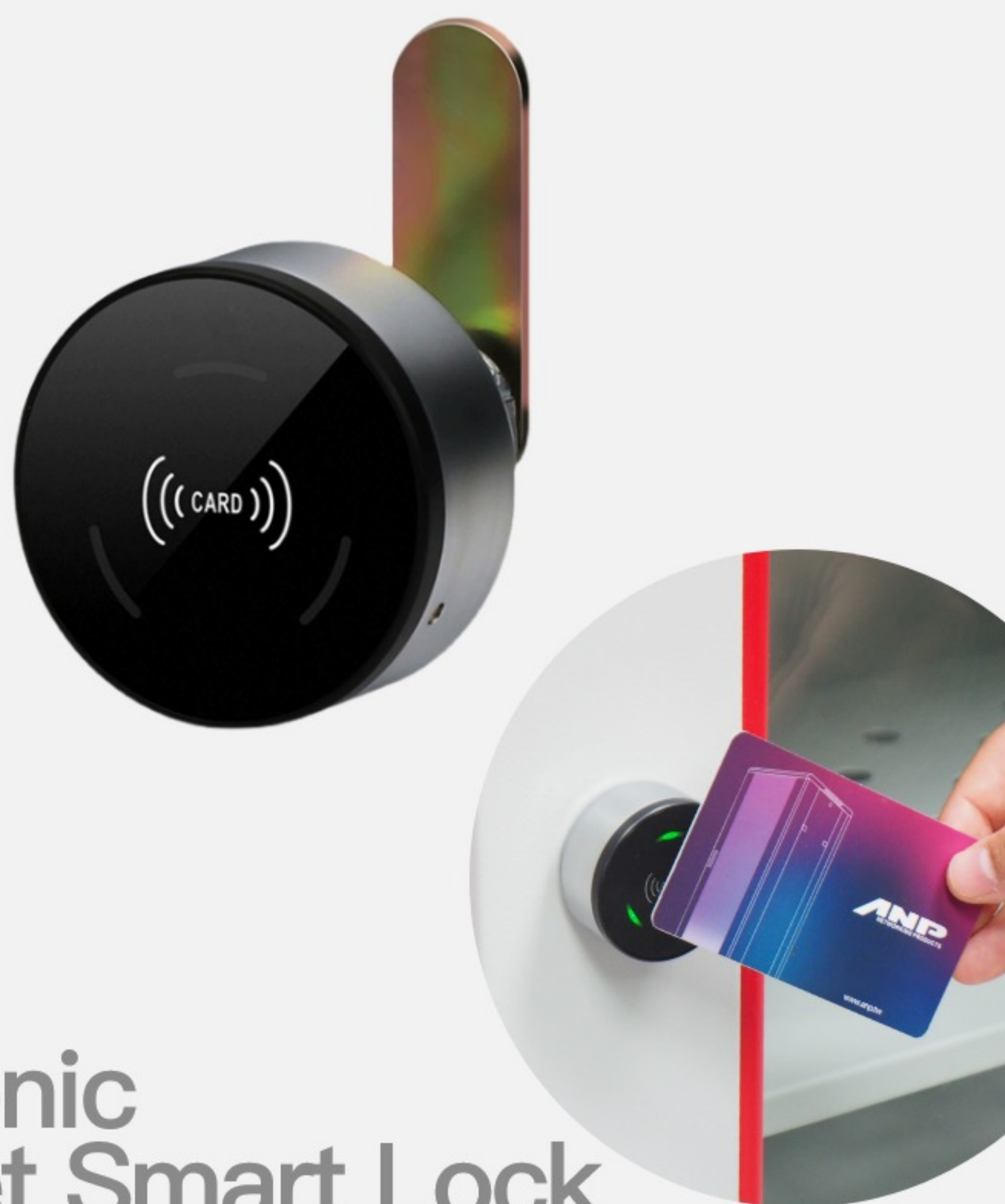

Electronic Cabinet Smart Lock

Electronic Lock
Applicable to 【ANP】 Wall Mount cabinets

AP-AT-E4035L | For 【ANP】 cabinets

- © The product specifications, dimensions, pictures and information mentioned in this catalog are for reference only, and the content may be updated at any time without prior notice.
- © The various data mentioned in this catalog may be different or have errors due to changes in the objective environment and other factors.

Products Index

AP-1845C6 Patch Cord ...	26	AP-CA8226042	7
AP-1007C3K	26	AP-CA8226622	7
AP-1006C6U	26	AP-CA8226632	7
AP-1005C6W	26	AP-CA8226642	7
AP-2804C6-12	27	AP-CA8226822	7
AP-2804C6-24	27	AP-CA8226832	7
AP-2804KBP-24	27	AP-CA8226842	7
AP-2804C3-25	27	AP-FA402	16
AP-AAM6100	24	AP-FA602	16
AP-AYBP-1U	23	AP-FA804	16
AP-AYBP-2U	23	AP-FM402	17
AP-AYBP-4U	23	AP-FMH02	17
AP-AY-C4035L	28	AP-FMH03	17
AP-AYLR000	23	AP-PDU615ASPK	25
AP-AYLR600	23	AP-PDU815AK	25
AP-AYLR800	23	AP-SAC24-1U	14
AP-AYMBKT-1	20	AP-SAC24-2U	14
AP-AYMBKT-2	20	AP-SAC26	14
AP-AYMBKT-3	21	AP-SAUL20	15
AP-AY-H200L	28	AP-SAUL26	15
AP-AT-E4035L	28	AP-SAUL28	15
AP-ATBRP-1UK	22	AP-SAS60	13
AP-ATBRP-0UK	22	AP-SAS66	13
AP-ATMP-1UK	25	AP-SAS68	13
AP-ATMP-2UK	25	AP-SAU66	14
AP-CATC66	21	AP-SAU68	14
AP-CATC68	21	AP-SAU60	14
AP-CATC60	21	AP-WA6116404	12
AP-CJBS	24	AP-WA6116406	12
AP-CA8116022	6	AP-WA6116409	12
AP-CA8116032	6	AP-WA6116609	12
AP-CA8116042	6	AP-WA6116612	12
AP-CA8116622	6	AP-WA6116615	12
AP-CA8116632	6	AP-WA-Castor	24
AP-CA8116642	6	AP-WMB-2UK	13
AP-CA8116822	6	AP-WMB-4UK	13
AP-CA8116832	6	AP-WMHC-1U	18
AP-CA8116842	6	AP-WMHC-2U	18
AP-CA8118842	9	AP-WMHD-1U	18
AP-CA8226022	7	AP-WMHD-2U	18
AP-CA8226032	7	AP-WMHV-10K	19
		AP-WMHV-25K	19
		AP-WMHV-D	19

Taoyuan:

TEL:03-313-6528

FAX:03-313-6529

No. 31, Ln. 290, Xincheng Rd., Luzhu Dist.,

Taoyuan City 338003, Taiwan (R.O.C.)

Taipei:

TEL:02-2871-7002

FAX:02-2871-7003

Business Hours: Monday – Friday AM9:00–PM5:00



Mail : service@anp.tw

Web : www.anp.tw Line@ : [@anp.tw](https://www.line.me/@anp.tw)